

# **USER MANUAL**

## **LOW RESISTANCE METERS**

**MMR-6500 • MMR-6700**

# MMR-6500 • MMR-6700

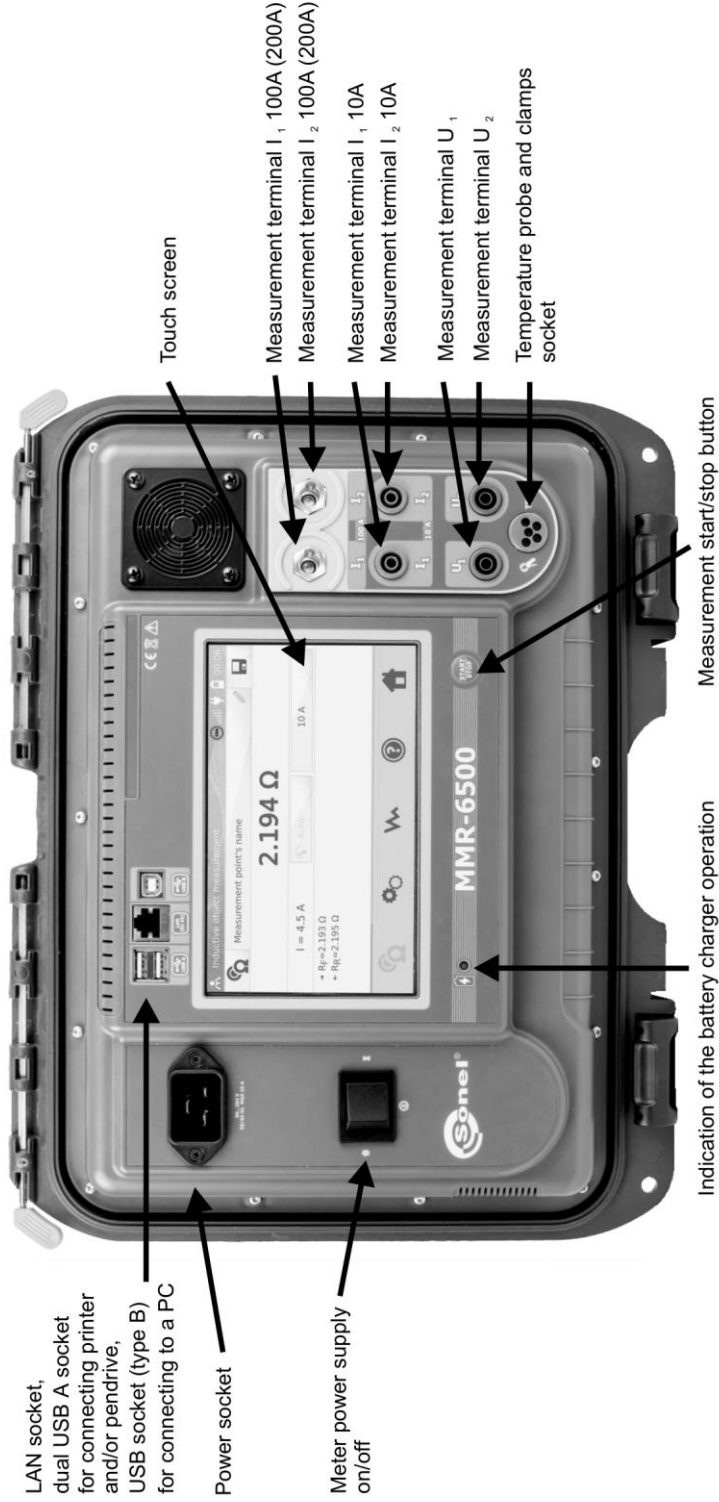

LAN socket,  
dual USB A socket  
for connecting printer  
and/or pendrive,  
USB socket (type B)  
for connecting to a PC

Power socket

Meter power supply  
on/off

Touch screen

Measurement terminal I<sub>1</sub>, 100A (200A)  
Measurement terminal I<sub>2</sub>, 100A (200A)

Measurement terminal I<sub>1</sub>, 10A  
Measurement terminal I<sub>2</sub>, 10A

Measurement terminal U<sub>1</sub>  
Measurement terminal U<sub>2</sub>

Temperature probe and clamps  
socket

Indication of the battery charger operation

Measurement start/stop button



# **LOW RESISTANCE METERS**

**MMR-6500  
MMR-6700**

**USER MANUAL**



**SONEL S.A.  
Wokulskiego 11  
58-100 Świdnica  
Poland**

Version 1.13 18.12.2024

Thank you for purchasing our low-resistance meter. MMR-6500 and MMR-6700 meters are modern, high-quality meters, easy and safe in operation. Please acquaint yourself with this manual in order to avoid measuring errors and prevent possible problems in operation of the meter.

# CONTENTS

<b>1 Safety</b>	<b>5</b>
<b>2 General settings - menu</b>	<b>6</b>
2.1 Meter settings	6
2.1.1 Energy saving	7
2.1.2 Sound settings	7
2.1.3 PIN code settings	8
2.1.4 QR reader settings	9
2.1.5 Display brightness settings	9
2.1.6 Wi-Fi configuration	10
2.1.7 Printer settings	11
2.2 Memory settings	12
2.2.1 Memory management	12
2.2.2 Object types database	13
2.2.3 Object names database	14
2.2.4 Resistance limits database	15
2.2.5 Temperature limits database	17
2.2.6 Material database	18
2.3 Software update	19
2.4 Service	20
2.5 User interface settings	21
2.5.1 Language selection	21
2.5.2 Selecting temperature unit	22
2.5.3 Selecting the startup screen	22
2.5.4 Changing the date and time	23
2.6 Information about the meter	23
2.7 Factory (default) settings	24
2.8 Emergency turning off the meter	24
2.9 Communication with PC	25
<b>3 Measurements</b>	<b>26</b>
3.1 Testing the resistance objects	26
3.2 Testing the inductive objects	31
3.3 Measurement with automatic method selection	35
3.4 Logger	36
3.5 Special features	39
3.5.1 Resistance measurement with clamps	39
3.5.2 Calibration of clamps	40
3.5.3 Temperature measurement	41
3.5.4 Windings temperature measurement	41
<b>4 Memory</b>	<b>46</b>
4.1 Memory management (clients, objects, measuring points and logs)	46
4.1.1 Entering the clients	46
4.1.2 Entering objects, subobjects, measurement points and logs	47
4.2 Storing the measurement results in the memory	52
4.2.1 Entering the results of measurements with previously organized memory	52
4.2.2 Entering the results of measurements without previously organized memory	54
4.3 Viewing memory data	57
4.4 "Search" in the memory	58
4.5 Copying customer data from the memory to USB stick and vice versa	60

4.6	<i>Deleting memory data</i> .....	61
<b>5</b>	<b>Report printing</b> .....	<b>63</b>
<b>6</b>	<b>Barcode reader</b> .....	<b>63</b>
<b>7</b>	<b>Power supply</b> .....	<b>64</b>
7.1	<i>Monitoring the power supply voltage</i> .....	64
7.2	<i>General rules for using Li-Ion rechargeable batteries</i> .....	64
7.3	<i>Battery pack charging procedure</i> .....	65
<b>8</b>	<b>Cleaning and maintenance</b> .....	<b>65</b>
<b>9</b>	<b>Storage</b> .....	<b>65</b>
<b>10</b>	<b>Dismantling and disposal</b> .....	<b>65</b>
<b>11</b>	<b>Technical data</b> .....	<b>66</b>
11.1	<i>Basic data</i> .....	66
11.2	<i>Other technical data</i> .....	67
<b>12</b>	<b>Manufacturer</b> .....	<b>68</b>

# 1 Safety

MMR-6500 and MMR-6700 meters are designed for measuring resistance of various types of connections (welded, soldered, butt) in electrical installations as well as in inductive devices (transformers, motors) and they are used to perform measurements that determine safety condition of electrical installations. Therefore, in order to provide conditions for correct operation and accuracy of obtained results, the following recommendations must be observed:

- Before you proceed to operate the meter, acquaint yourself thoroughly with the present manual and observe the safety regulations and specifications provided by the producer.
- MMR-6500 and MMR-6700 meters are designed to measure low-resistance values. Any application that differs from those specified in the present manual may result in a damage to the device and constitute a source of danger for the user.
- In case of measurements on systems, components and devices that may be under dangerous voltage, MMR-6500 and MMR-6700 may be used only by qualified persons who are authorized to work on electric installations. Unauthorized use of the meter may result in its damage and may be a source of serious hazard to the user.
- Using this manual does not exclude the need to comply with occupational health and safety regulations and with other relevant fire regulations required during the performance of a particular type of work. Before starting the work with the device in special environments, e.g. potentially fire-risk/explosive environment, it is necessary to consult it with the person responsible for health and safety.
- It is unacceptable to operate the device when:
  - ⇒ a damaged meter which is completely or partially out of order,
  - ⇒ a meter with damaged insulation,
  - ⇒ a meter stored for an excessive period of time in disadvantageous conditions (e.g. excessive humidity). **If the meter has been transferred from a cool to a warm environment with a high level of relative humidity, do not start measurements until the meter is warmed up to the ambient temperature (approximately 30 minutes).**
- Before measurement make sure that test leads are connected to appropriate measuring terminals.
- Do not power the meter from other sources than those specified in this manual.
- Repairs may be performed only by an authorized service point.
- The devices meet the requirements of EN 61010-1, EN 61010-2-030 and EN 61010-031.

**Note:**

**The manufacturer reserves the right to introduce changes in appearance, equipment and technical data of the meter.**

**Note:**

**An attempt to install drivers in 64-bit Windows 8 and Windows 10, may result in displaying "Installation failed" message.**

**Cause: Windows 8 and Windows 10 by default block drivers without a digital signature.**



**Solution: Disable the driver signature enforcement in Windows.**

## 2 General settings - menu

Before turning the device on for the first time, charge the meter's battery pack according to the charging procedure in chapter 7.3.

When the meter is turned on, it displays the main menu.

Indication of overheating of the power supply adapter, battery or measuring current controller and no battery indication.

Full memory indicator –  it is shown, when 30% of free memory is available,  it is shown, when 20% of free memory is available.

Wi-Fi signal strength

Power supply from mains



Battery charge level, x – indicates empty battery or no battery in the compartment.

### 2.1 Meter settings

① In the main menu, click icon .



Click **Meter Settings** button.



## 2.1.1 Energy saving

In order to save its rechargeable battery, the meter automatically shuts off or blanks the screen after an adjustable inactivity period.

1

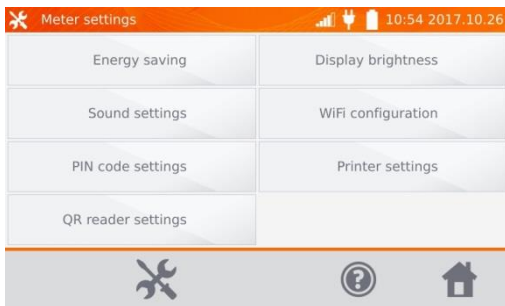

Click **Energy saving** button.

2

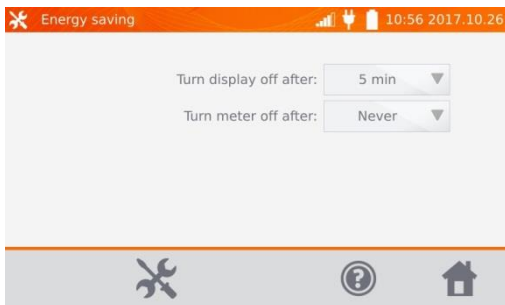

Set the inactivity time for blanking the screen and turning off the meter.

## 2.1.2 Sound settings

1

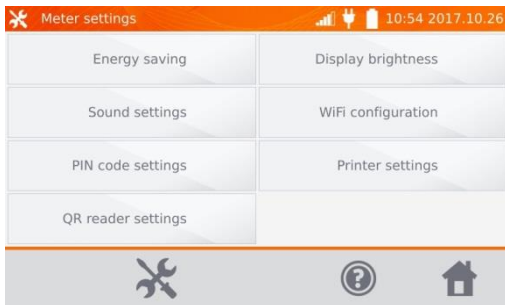

Click **Sound Settings** button.

2

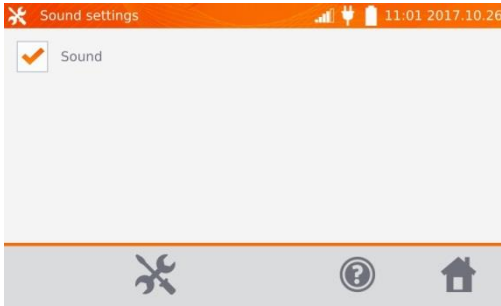

Click the box to turn on (  ) or off the sound signals.

## Note:

- Alarm signals are active even if the sound signals are off.

### 2.1.3 PIN code settings

The PIN code is used for network connection with the meter.

1

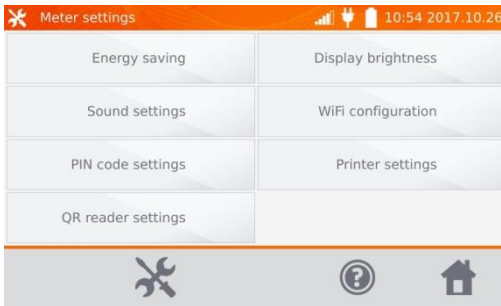

Click **PIN code settings** button.

2

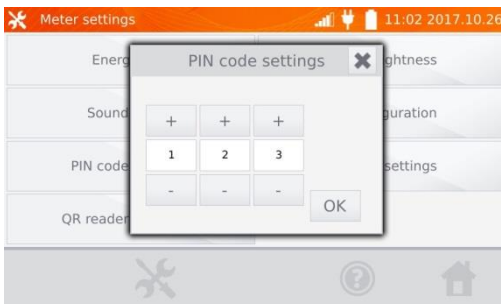

Use "+" and "-" buttons to set the code and confirm it by pressing **OK**.

The PIN code is used for communication with the PC software. The factory code is 123.

## 2.1.4 QR reader settings

1

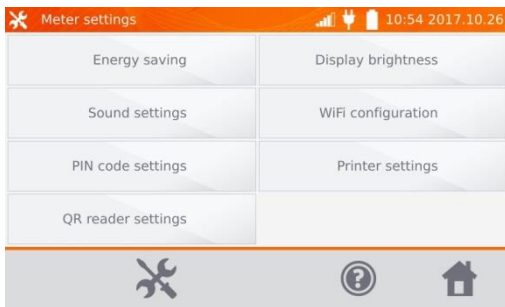

Click **QR reader settings** button.

2

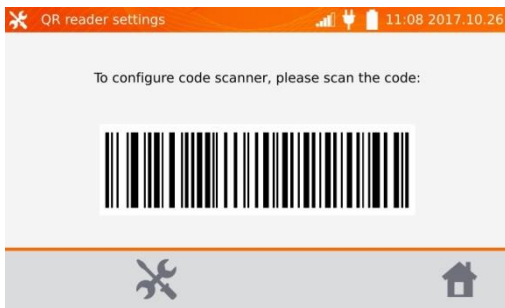

To configure the reader, please scan the displayed code.

## 2.1.5 Display brightness settings

1

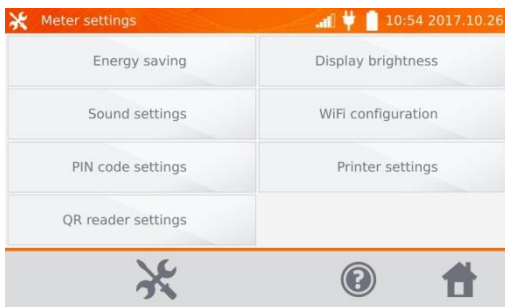

Click **Display brightness** button.

2

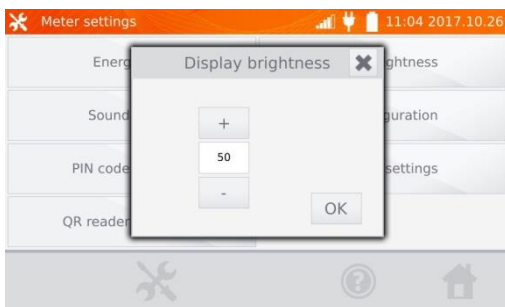

Use "+" and "-" buttons to set the desired brightness and confirm it by pressing **OK**.

## 2.1.6 Wi-Fi configuration

1

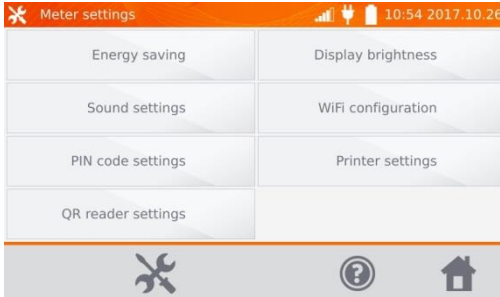

Click **WiFi configuration** button.

2

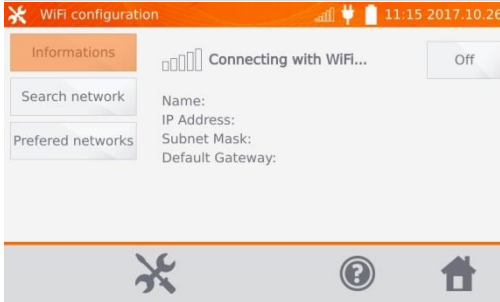

To see local active WiFi networks, click **Search network** button.

3

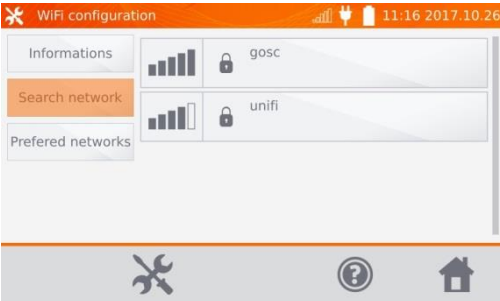

The meter detected networks secured by password. Click the name of the network to enter the password.

4



Enter the password and confirm it by pressing . The meter connects to the network, which is automatically included in the list of trusted networks.

5

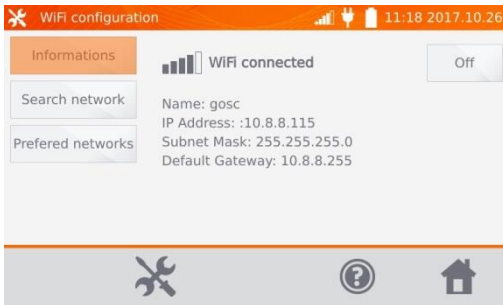

You may use **OFF** button to turn off WiFi.

6

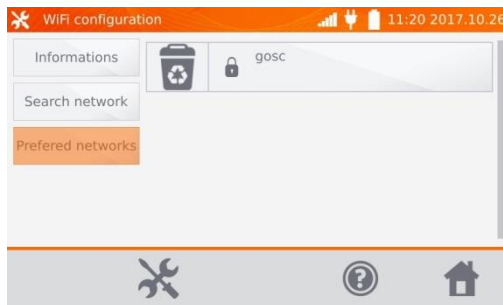

After clicking **Prefered networks** button, the meter will display networks saved in its memory.

By pressing button  you may delete the network.

## 2.1.7 Printer settings

The meter is compatible with Sato CG2 printer.

1

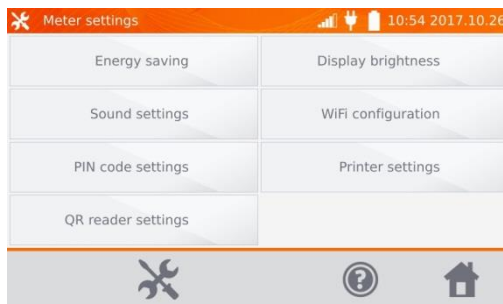

Click **Printer Settings** button.

2

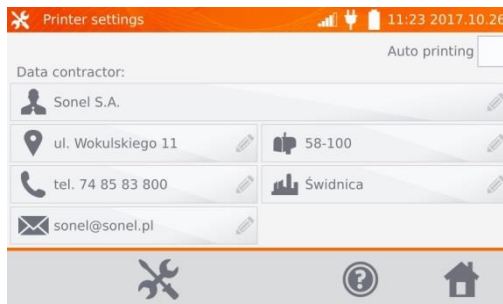

By clicking individual fields, you may change the data of person/company performing the measurements, which will be printed. Marking the **Auto printing** box will automatically print when saving the measurement result to memory provided the printer is on.

## 2.2 Memory settings

- 1 In the main menu, click button .

Note: By pressing  button, you may enter settings or enter the higher level in the settings.



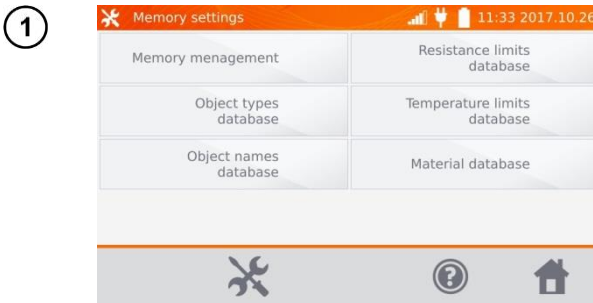

Click **Memory Settings** button.

### 2.2.1 Memory management

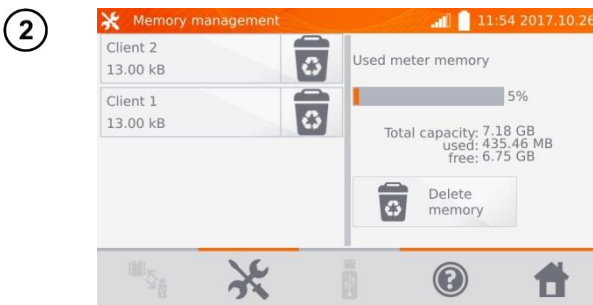

Click **Memory management** button



This option allows you to read the % of the used memory and to clear it: after clicking **Delete memory** all clients are deleted with their objects and measurement results. By pressing button  located next to each customer, you can also delete individual customers.

## 2.2.2 Object types database

This is a list of types of tested resistive and inductive objects.

①

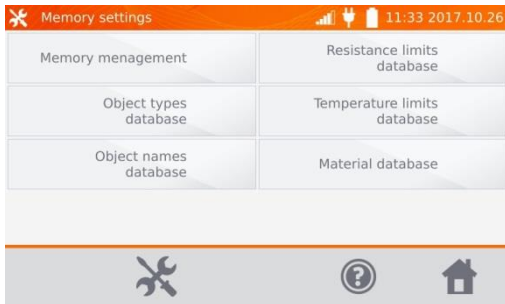

Click **Object types database** button.

②

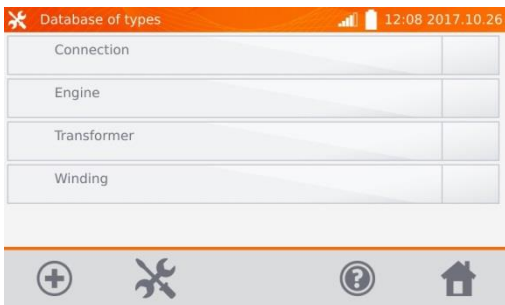

The meter has 4 default types saved in its memory. Use **+** button to add a new type of the tested object.

③



Enter a new type of the object being tested.

④

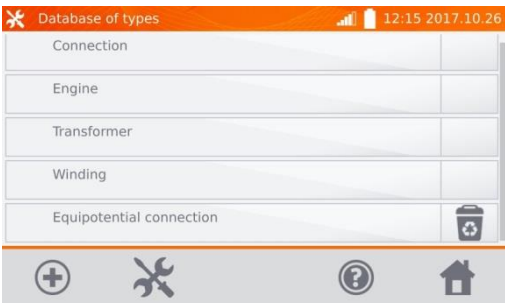

Added types may be deleted by pressing .

### 2.2.3 Object names database

It is a list of names of tested objects or measurement points.

1

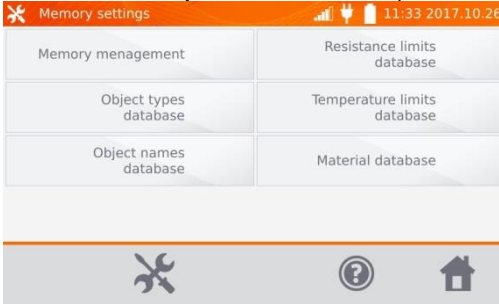

Click **Object names database** button.

2

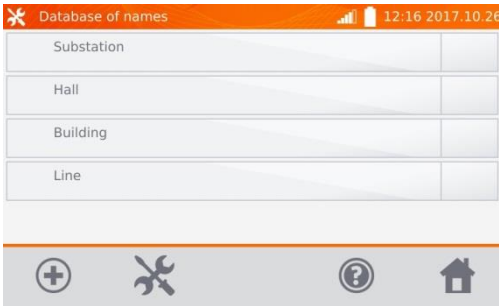

The meter has 4 default names saved in its memory. Use **+** button to add a new name.

3



Enter the name of the object.

4



Added names may be deleted by pressing .



## 2.2.4 Resistance limits database

The specified limits may be used to automatically assess the validity of the results of resistance measurements.

1

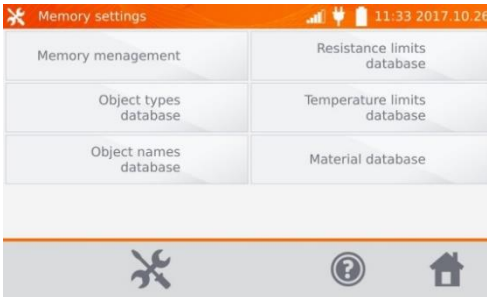

Click **Resistance limits database** button.

2

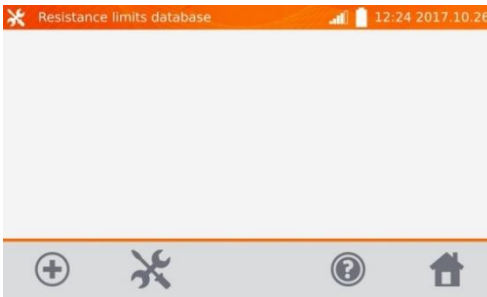

Click **+**, to add a new limit.

3

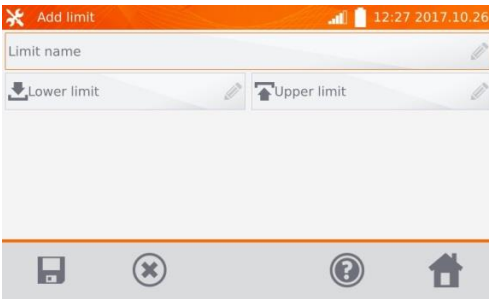

Click **Limit name** box.

4



Enter the name of the limit.  
Use **▶** button to go to the lower limit setting.

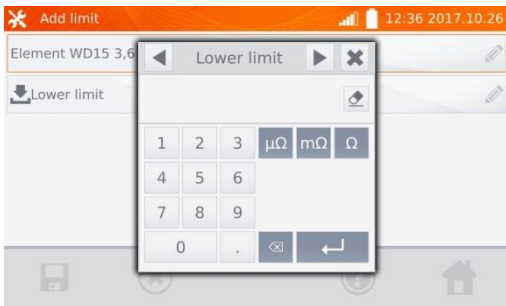

5

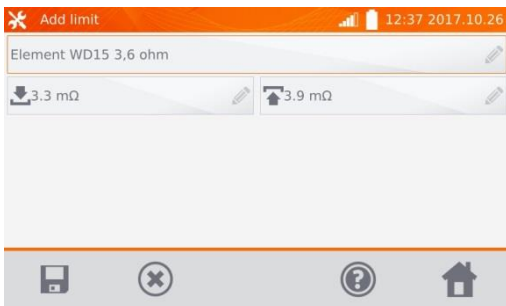

Enter the lower limit. Use  button to go to the upper limit setting. You can also set only one of the limits.

6



Use  button to save the limit in the memory. Use  button, to exit without saving.

7

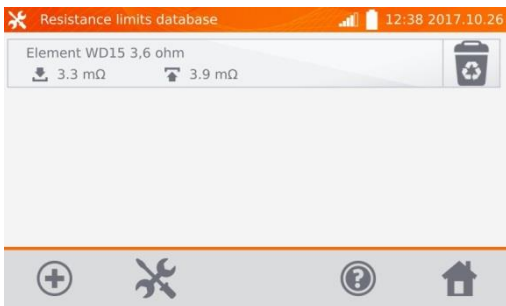

Use  to cancel the limit.

## 2.2.5 Temperature limits database

The specified limits may be used to automatically assess the validity of the results of temperature measurements.

1

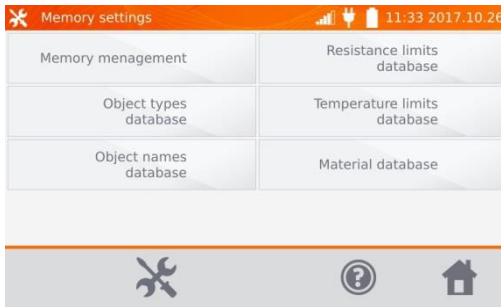

Click **Temperature limits database** button.

2

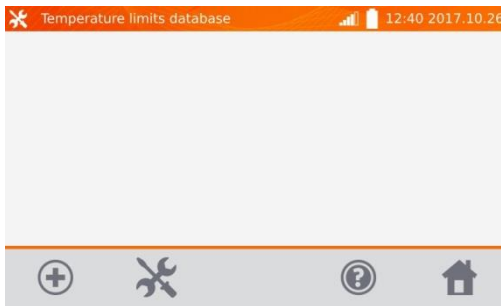

Click **+**, to add a new limit.

3

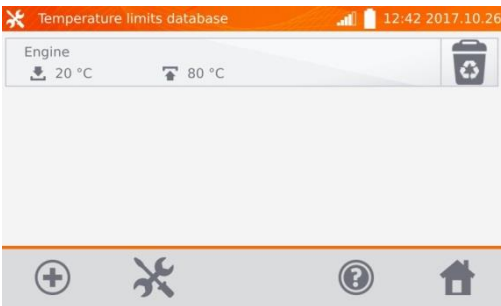

Enter and save the limits using the same method as described in section 2.2.4.

Use **🗑️** to cancel the limit.

## 2.2.6 Material database

The database contains the temperature coefficients of resistance for different materials, used in measurements with temperature compensation.

1

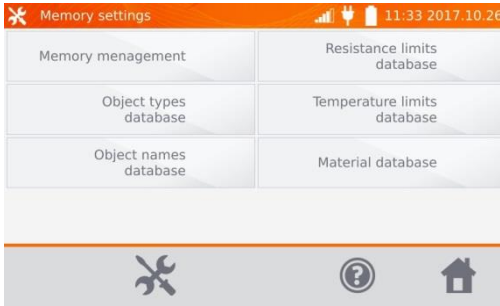

Click **Material database** button.

2



The meter has 5 defaults materials saved in the memory, together with the thermal resistance coefficients of: copper, aluminium, tin, steel and silver. Use  button to add a new material.

3

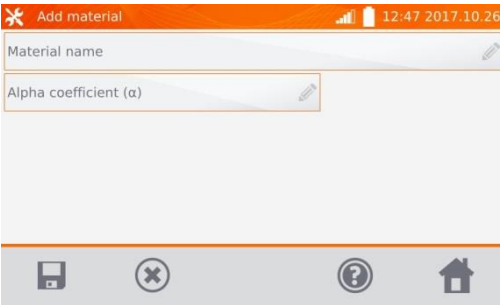

Enter and save the material and a coefficient, using the same method as described in section 2.2.4.

4

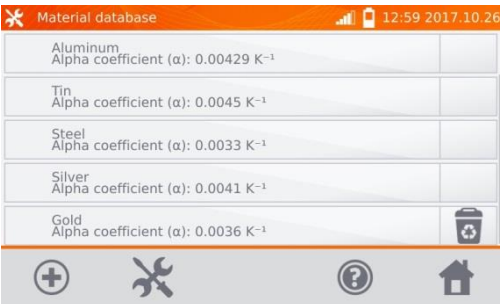

Use  button to delete the added material.

## 2.3 Software update

The software of the meter is periodically modified. You may download its current version from [www.sonel.pl](http://www.sonel.pl).

① In the main menu, click icon .

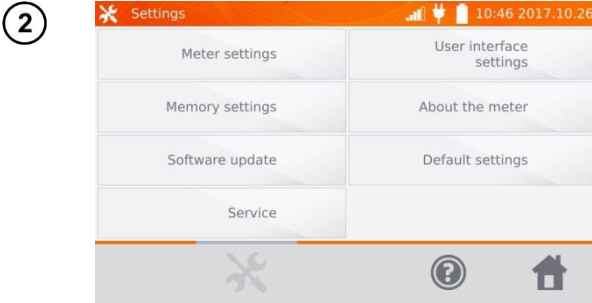

Click **Software update** button.



Read the displayed text. To perform an update insert the USB drive with the update files and click **Update** or ensure Internet connection of the meter via WiFi, and click **Update** button.

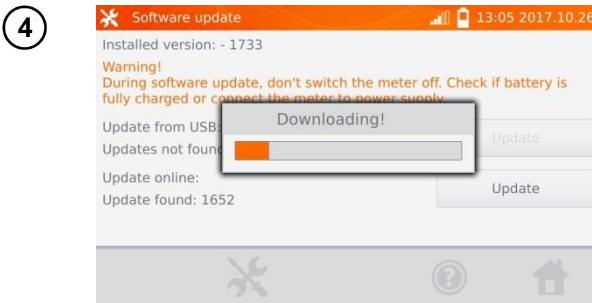

The meter is downloading software.

5

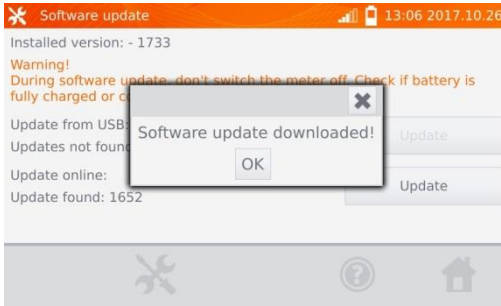

Click OK to run the update or close the window to cancel.

## Note:

- Update is performed automatically and may be divided into a few stages. During the update, do not turn off the power supply of the meter and do not remove the USB drive. The update process is continued until the meter displays the main MENU screen.

6

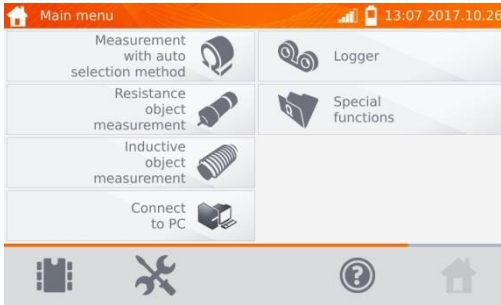

Only at this point, you can turn off the power supply of the meter or start its use.

## 2.4 Service

This function is available for factory servicing and is protected by password.

## 2.5 User interface settings

① In the main menu, click icon .

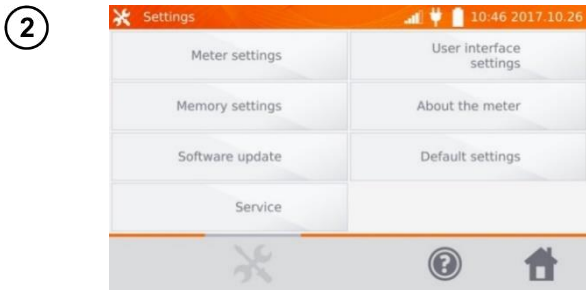

Click **User interface settings** button.

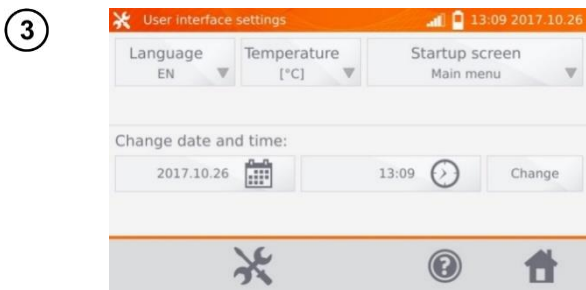

### 2.5.1 Language selection

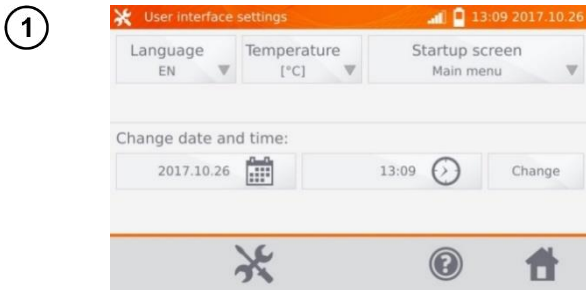

Click **Language** button.

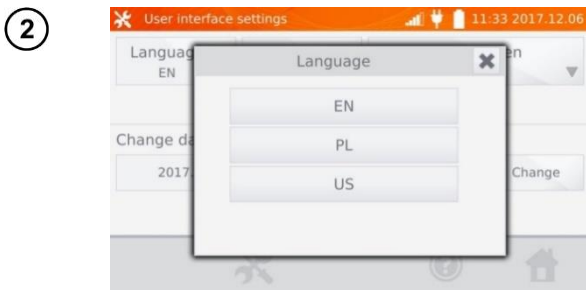

Click the selected language.

## 2.5.2 Selecting temperature unit

1

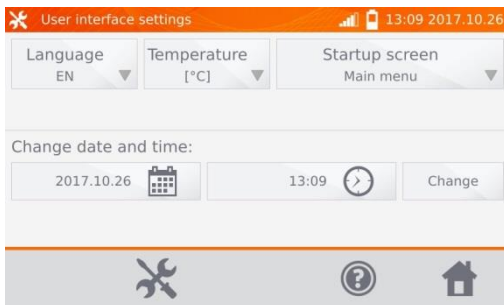

Click **Temperature** button.

2

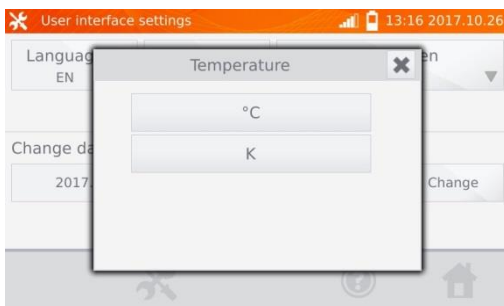

Click the button of selected unit.

## 2.5.3 Selecting the startup screen

1

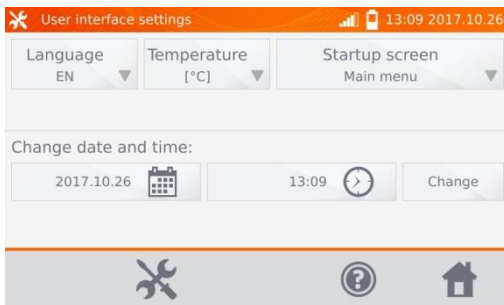

Click **Startup screen**.

2

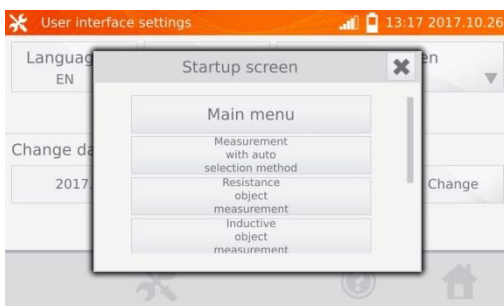

Click the selected startup screen (the screen will be automatically shown after turning on the meter). This feature is useful for making measurements of a given type for a longer period.



## 2.5.4 Changing the date and time

1

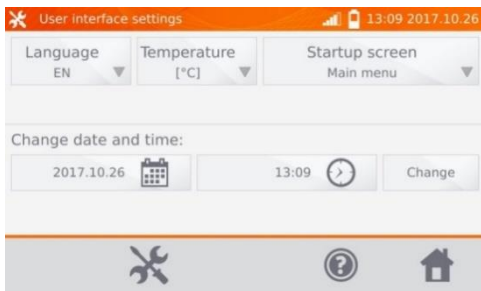

Click date button.

2

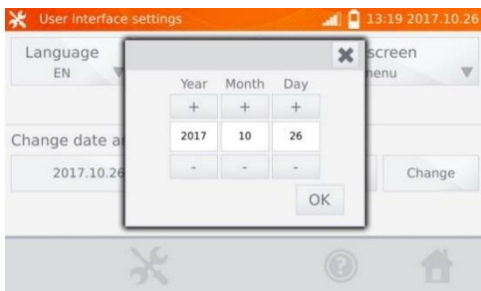

Use "+" and "-" buttons to set year, month and day, then and confirm it by pressing **OK**. Similarly, you may set the time. To make changes, click **Change** button.

## 2.6 Information about the meter

1

In the main menu, click icon .

2

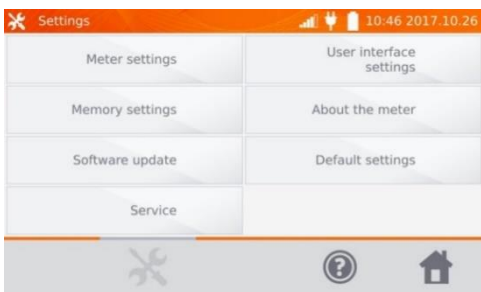

Click **Meter infor** button.

3



The screen will display information on the meter and its manufacturer.

## 2.7 Factory (default) settings

① In the main menu, click icon .

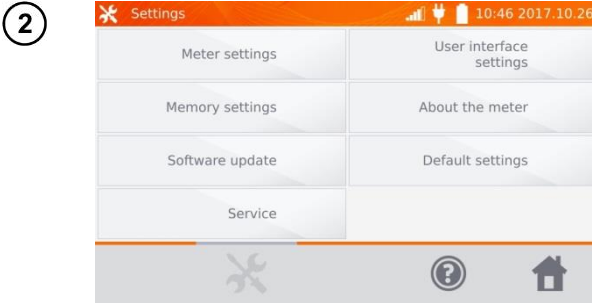

Click **Default Settings** button.

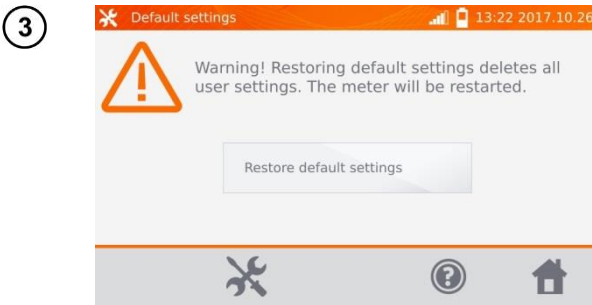

Read the note and click the button to restore the default settings, click  button to cancel and return to the menu.

The following elements are restored to the default settings:

- measurement settings,
- list of object types,
- list of object names,
- list of materials,
- list of R limits,
- list of T limit,
- sound settings,
- default startup screen,
- the list of WiFi networks,
- temperature unit,
- PIN code settings,
- energy saving settings,
- display brightness.

## 2.8 Emergency turning off the meter

To turn off the meter in an emergency, press and hold **START/STOP** button.

## 2.9 Communication with PC

1

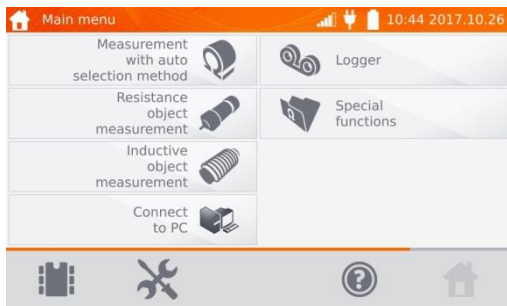

Press **Connect to PC**.

2

On your PC run **Sonel Reader** or **Sonel Reports PLUS**.

3

To terminate the connection press **✕**.

### 3 Measurements

#### Notes:

- The measurement with temperature compensation is performed when the user wants to know the resistance of the object at a certain reference temperature, and the measurement is made at another temperature. Basing on the temperature coefficient of resistance  $\alpha$  of the measured object, the meter calculates the resistance value at the reference temperature.
- When using the function of temperature compensation, the declared measurement accuracy is valid for the result before the compensation.
- If the current test leads are not connected, a message appears: **Lack of continuity of current leads.**
- If the voltage test leads are not connected, a message appears: **Lack of continuity of voltage leads.**

#### 3.1 Testing the resistance objects

1

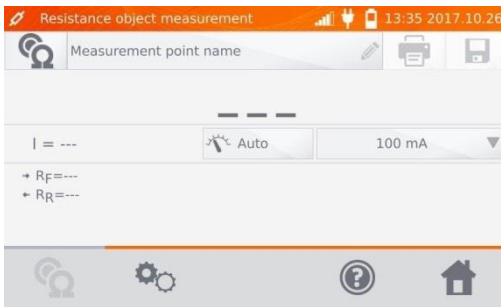

2



When necessary, name the measuring point.

#### Note:

- After entering the name of the measuring point, the measurement result will be saved in the memory and after selecting the client and object (subobject) you may simply click  button to create and save the point automatically. When during the logging process you click a point already existing in the memory, then its name created during the memory management will be overwritten by the name typed in the measurement box.

3

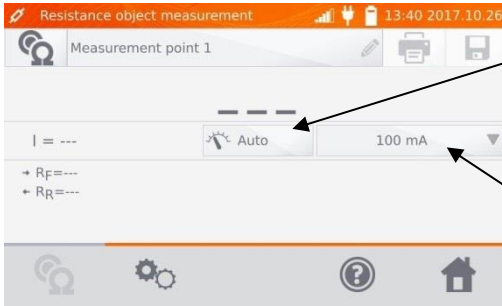

Auto/Manual switch (auto / manual range selection):  
 Auto - the measuring current is limited to a value not exceeding the set value,  
 Manual - measuring current has the set value.

Setting the measuring current.

4

Use  to go to the next settings.

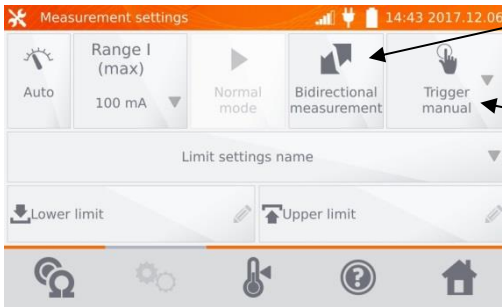

Switching Unidirectional/Bidirectional measurement.

Selecting trigger method:  
 - manual: use **START/STOP** button  
 - automatic: by connecting test leads to the object  
 - continuous: the measurement is triggered and ended by pressing **START/STOP** button.

Boxes for setting the range and measurement current on the screen above correspond to the same boxes shown in the previous screen.

### Notes:

- Automatic and continuous measurement triggering mode is not active for  $I > 10$  A.
- Measurement with current  $> 10$  A is possible only when with power supplied from mains.
- Bidirectional measurement is used to compensate the potential present at the contact point of two different conductors. In this case, the main result of the measurement is the average of results from individual directions.
- After selecting automatic trigger, the first measurement must be started by pressing **START/STOP** button, next measurements may be initiated by connecting the test leads to the object.
- automatic trigger operates correctly for resistance  $\leq 4$  k $\Omega$ , above this value there is no guarantee of correct operation.

- 5 When necessary, select resistance limits from the database (click **Limit settings' name**) or set the required limits for the performed measurement by clicking **Lower limit** and/or **Upper limit**.

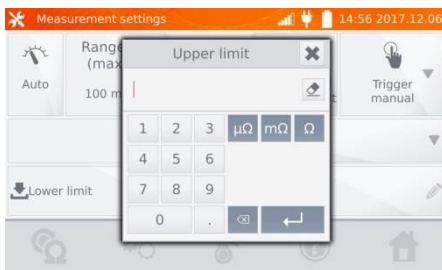
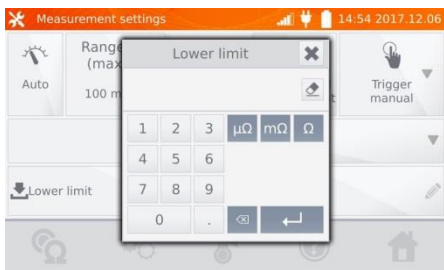
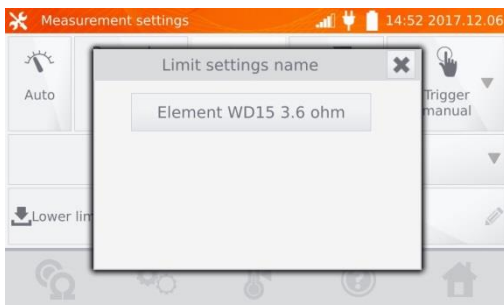

- 6 Click , to enter the temperature settings. After checking "Temperature compensation" box, the meter uses the specified temperatures and temperature coefficient of resistance to calculate the resistance at the reference temperature.

Turning on/off the temperature compensation.

Enter the ambient temperature – optional.

Enter the temperature of the object or measure it with a thermometer connected to the meter socket.

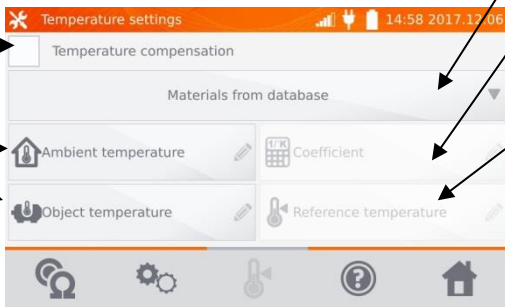

Select a material from the database or

enter a coefficient for the tested object.

Enter the reference temperature, for which the result will be calculated.

## Notes:

- When you activate the temperature compensation, set all the values (not necessarily the ambient temperature) to exit to the measurement screen.
- The ambient temperature is added to the measurement report.

7 Press , to enter the measurement.

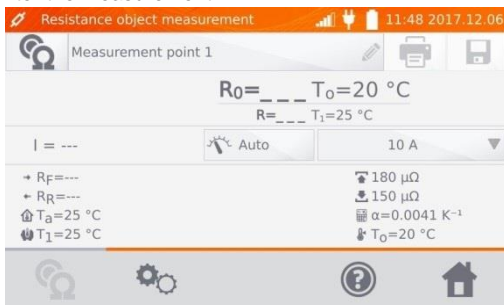

8 Connect the meter to the tested object. Press **START/STOP**.

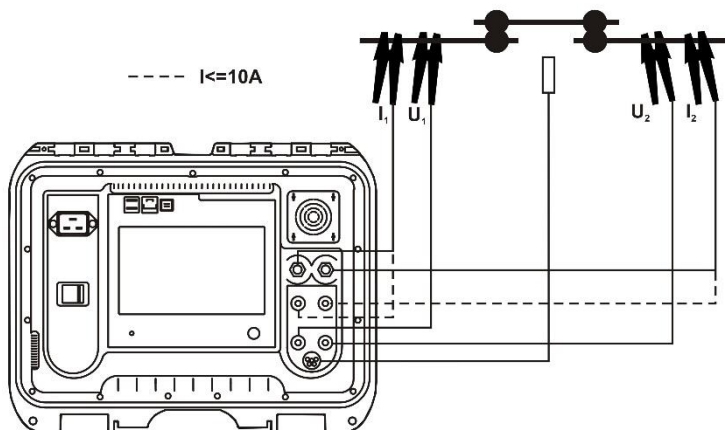

## Note:

- connection of test leads to an outlet sockets of 10 A locks the measurement for currents > 10 A.



Correct result:  $R_0$  within limits.



Incorrect result:  $R_0$  outside limits.

$R_0$  – resistance at the reference temperature

$R_F$  – resistance at the measuring current flowing in the assumed positive direction

$R_R$  – resistance at the measuring current flowing in the assumed negative direction

$T_a$  – ambient temperature

$T_1$  – object temperature

$T_0$  – reference temperature

$\alpha$  – temperature coefficient of resistance

- upper limit

- lower limit

### Notes:

- The measuring current is obtained from the current source.
- During measurements with high currents, high-current connectors may overheat due to: excessive current flow, connector poor tightening, contamination or damage.
- Declared measurement uncertainty refers to the measured value; for value calculated with the reference temperature the uncertainty is not specified.

- The result may be entered into the memory by pressing button (see sec. 4.2).



## 3.2 Testing the inductive objects

1

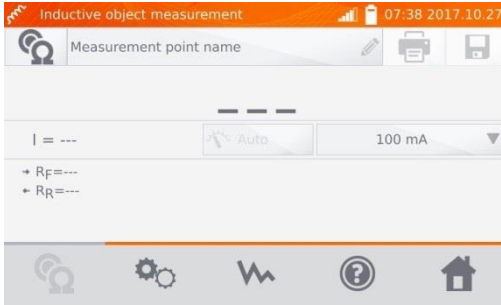

2



When necessary, name the measuring point.

3

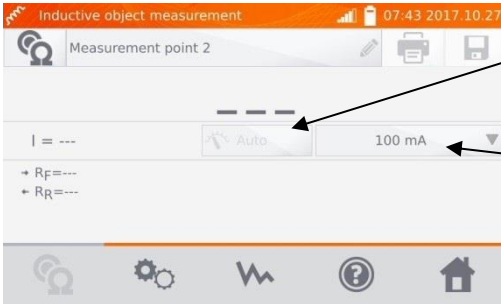

When measuring inductive objects, only Auto mode is available - the measuring current is limited to a value not exceeding the set value,

Setting the measuring current limits.

4

Use  to go to the next settings.

Selection of measurement mode:

- normal
- continuous: the measurement continues until it is turned off by pressing **START/STOP** button

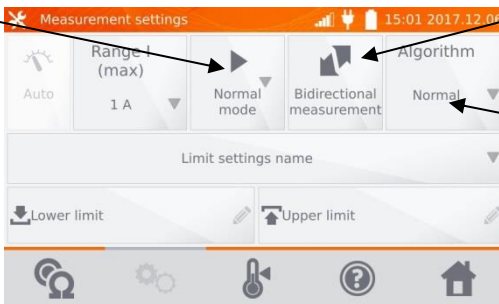

Switching Unidirectional/Bidirectional measurement.

Algorithm selection:

- normal
- fast: greater tolerance for result stability criterion
- special - it can be used, among others, for amorphous cores; it is also recommended in the case of high power transformers measurement.

Boxes for setting the range and measurement current on the screen above correspond to the same boxes shown in the previous screen.

**Notes:**

- Current > 10 A is not available in this function.
- Bidirectional measurement is used to compensate the potential present at the contact point of two different conductors. In this case, the main result of the measurement is the average of results from individual directions.
- Amorphous core is made of amorphous sheet, which has a non-crystalline structure that is closer to glass than metal. No-load losses in such a transformer are much lower than in traditional transformers. The process of measuring the resistance, due to the nature of the object, contains a measurement algorithm modified in relation to normal inductive objects.
- When measuring large transformers with a discharged battery and long measuring leads, there may be a problem with the stabilization of the measurement result (too high power consumption from the discharged battery). In this case:
  - charge the battery or
  - work with mains power or
  - shorten the test leads.

- 5 Select resistance limits from the database (click **Limit settings' name**) or set the required limits for the performed measurement by clicking **Lower limit** and/or **Upper limit**.

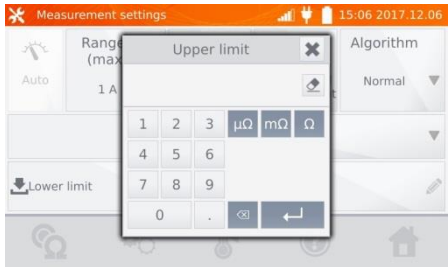
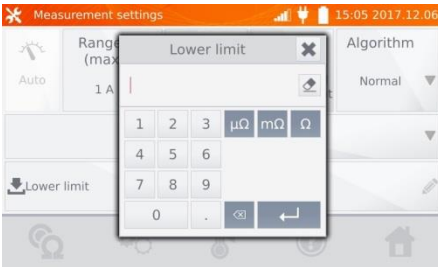
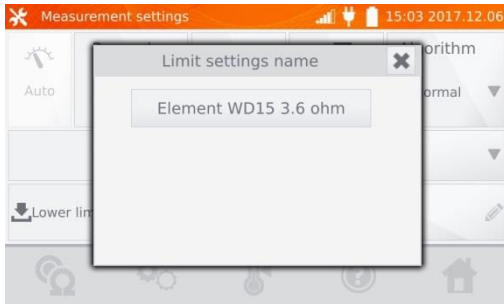

- 6 Click , to enter the temperature settings. After checking "Temperature compensation" box, the meter uses the specified temperatures and temperature coefficient of resistance to calculate the resistance at the reference temperature.

Turning on/off the temperature compensation

Enter the ambient temperature – optional.

Enter the temperature of the object or measure it with a thermometer connected to the meter socket.

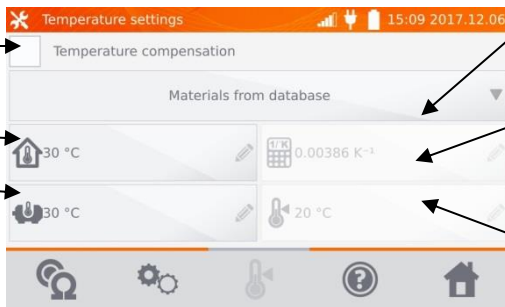

Select a material from the data-base or

Enter a coefficient for the tested object

Enter the reference temperature

### Notes:

- When you activate the temperature compensation, set all the values (not necessarily the ambient temperature) to exit to the measurement screen.
- The ambient temperature is added to the measurement report.

- 7 Press , to enter the measurement.

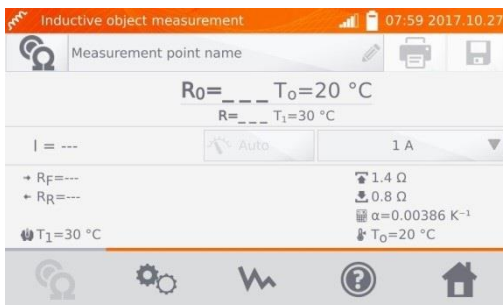

8 Connect the meter to the tested object. Press **START/STOP**.

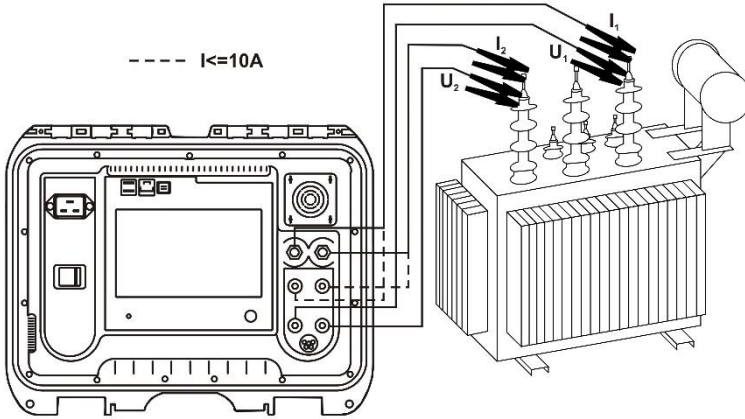

Correct result:  $R_0$  within limits.



Incorrect result"  $R_0$  outside limits.

- $R_F$  – resistance at the measuring current flowing in the assumed positive direction
- $R_R$  – resistance at the measuring current flowing in the assumed negative direction
- $T_a$  – ambient temperature
- $T_1$  – object temperature
- $T_0$  – reference temperature
- $\alpha$  – temperature coefficient of resistance
- ↑ - upper limit
- ↓ - lower limit

9

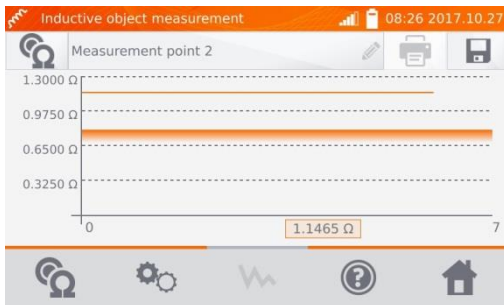

Use  button to display the graph of resistance over time.

#### Notes:

- It is recommended to use the maximum source power (set the current limit high enough), because then the core is saturated faster and the result stabilizes faster.
- Declared measurement uncertainty refers to the measured value; for value calculated with the reference temperature the uncertainty is not specified.
- Resistance values > 2 kΩ displayed on the screen during the measurement are shown for information purposes - they have no specified accuracy.
- The result may be entered into the memory by pressing  button (see sec. 4.2).

### 3.3 Measurement with automatic method selection

1

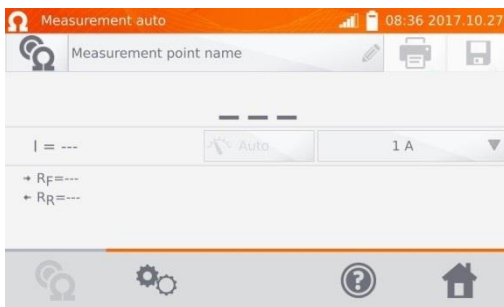

The measurement is performed as in the case of testing the inductive objects. If based on the difference between the instantaneous and average resistance during the result stabilization, the meter determines that the object is resistive, it will complete the measurement faster.

#### Notes:

- Current > 10 A is not available in this function.
- For high power transformers it is recommended to use the measurement in the same mode as for inductive objects.

### 3.4 Logger

The logger is designed for logging the results with the interval from 1 second to 15 minutes.

1

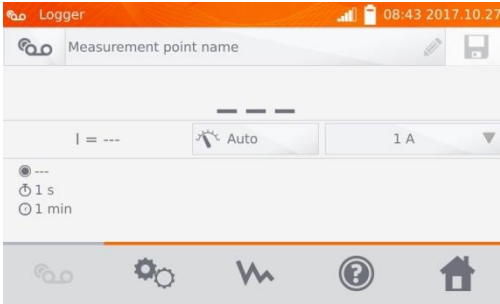

2



When necessary, name the measuring point.

3

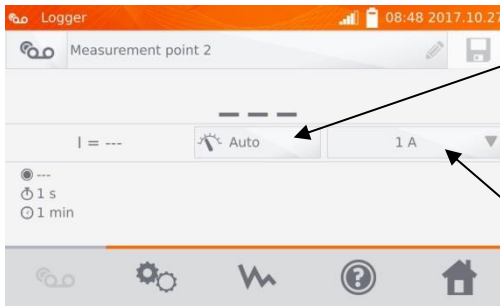

Switching between Auto/Manual mode:  
Auto - the measuring current is limited to a value not exceeding the set value,  
Manual - measuring current has the set value.  
When measuring inductive objects, only Auto mode is available.

Setting the measuring current values or limits.

④ Use  to go to the next settings.

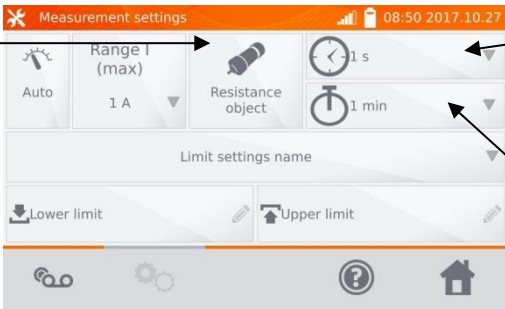

Selecting the object type:  
 - resistance  
 - inductive

Selecting the time interval: 1 s, 5 s, 10 s, 15 s, 1 min, 5 min, 10 min, 15 min.

Selecting logging time: 1 min, 5 min, 10 min, 15 min, 30 min.

**Notes:**

- Current > 10 A is not available in this function.
- The selected sampling time must be lower than the time set for logging, otherwise the meter will set the default times.

⑤ Select resistance limits from the database (click **Limit settings' name**) or set the required limits for the performed measurement by clicking **Lower limit** and/or **Upper limit**.

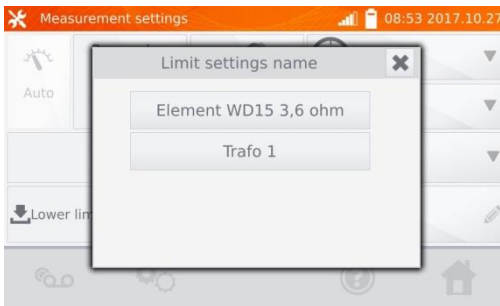
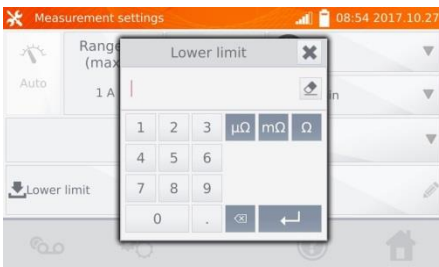
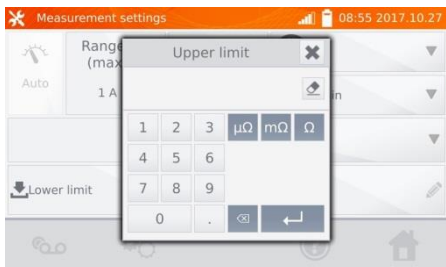



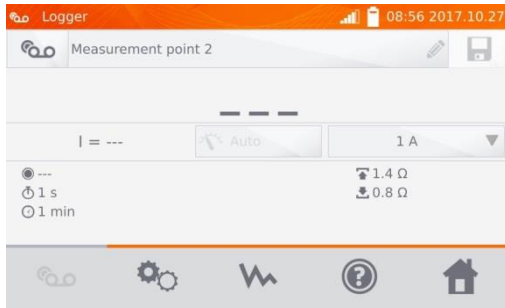

6 Press  button, to enter the logger.

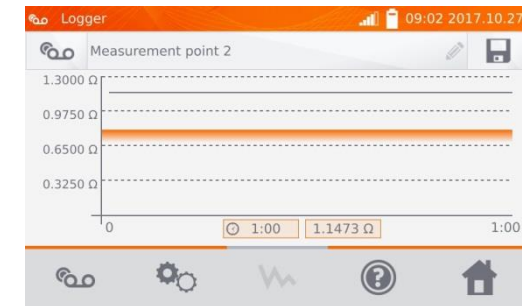
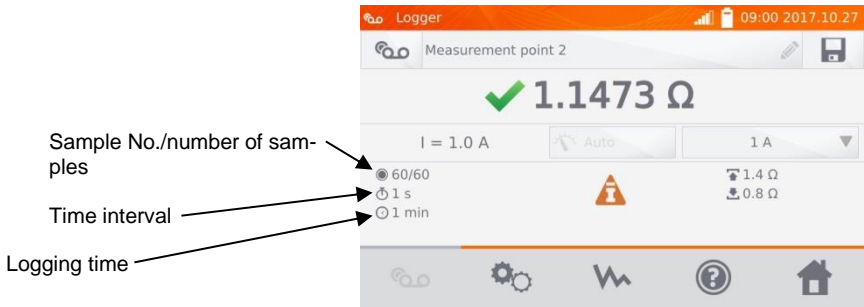

7 Connect the meter to the tested object. Press **START/STOP**.

8



Use  button to display the graph of resistance over time - both during the logging process and after its completion.

**Note:**

- After the logging process, the result may be entered into the memory by pressing  button (see sec. 4.2). The values of individual samples may be read by viewing memory (see sec. 4.3).



## 3.5 Special features

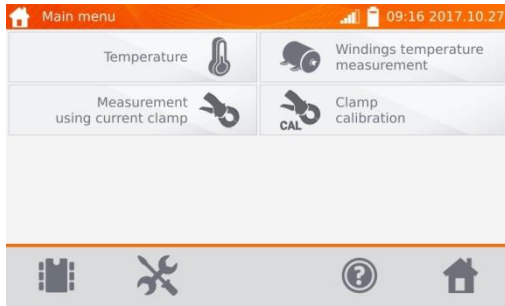

The meter has four additional functions:

- temperature measurement,
- windings temperature measurement based on the resistance measurement,
- measurement with current clamps,
- calibration of clamps.

### 3.5.1 Resistance measurement with clamps

The measurement with clamps is used for both-side grounded objects, e.g. circuit breakers. The clamps are used to measure current flowing through the grounding and its value is used to calculate the value of current actually flowing through the measured object.

- 1 Connect the meter according to the drawing.

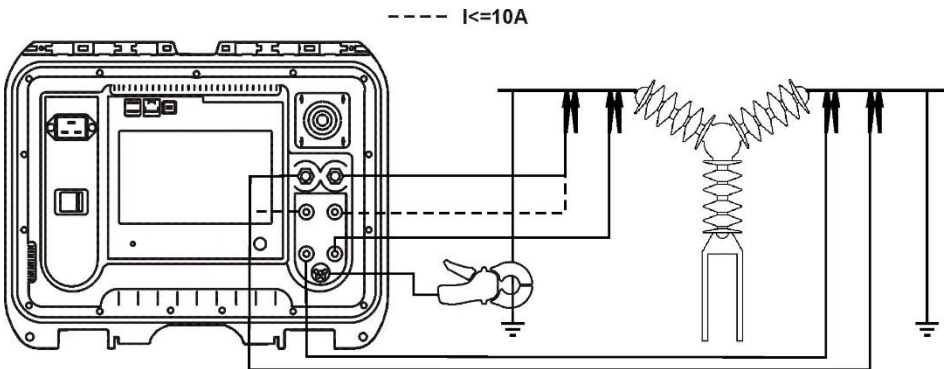

2

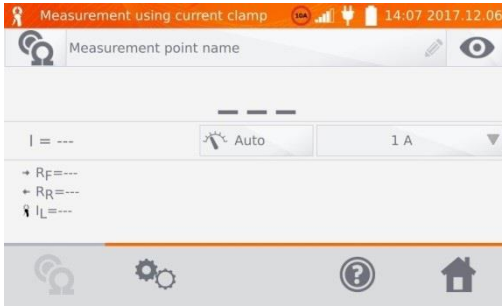

Press **START/STOP** button.

3

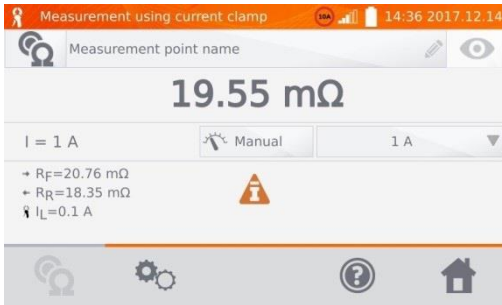

In addition to the resistance, the meter also displays the value of current measured with clamps.

**Note:**

- Disconnected clamps are signalled by displayed icon .

**3.5.2 Calibration of clamps**

Before first use, the clamps must be calibrated. To do this, short circuit both current inputs, fix the clamps onto the cable and press **START/STOP** button. When clamps are calibrated, the current is always less than 10 A, so you can use 10 A or 100 A (200 A) sockets.

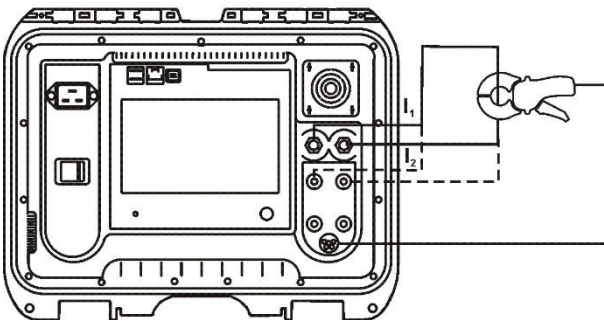

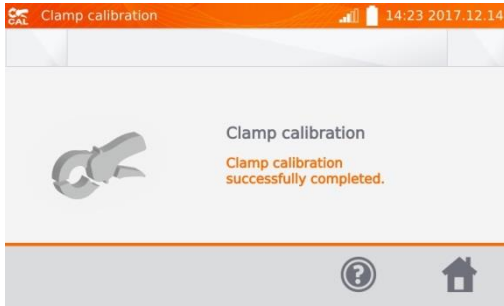

### 3.5.3 Temperature measurement

① Connect the temperature probe to the appropriate socket in the meter.



Read the temperature.

### 3.5.4 Windings temperature measurement

This function allows to calculate the temperature of windings for a heated object - e.g. motor, basing on the measured winding resistance at ambient temperature and after a period of operation, taking into account the temperature coefficient of resistance known for the winding material. It is assumed that after a significant stoppage time, the temperatures of the winding and motor block are the same. After a working period, initially the winding temperature differs from the temperature of the motor block. It may be calculated by measuring the change of the winding resistance.



2



When necessary, name the measuring point.

3

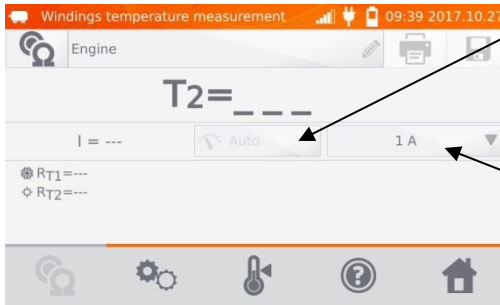

The method of supplying the measuring current is non-adjustable and set on Auto mode - the measuring current is limited to a value not exceeding the set value.

Setting the measuring current values or limits.

4

Use  button to go to limit settings (mode, measurement and triggering are set as non-adjustable).

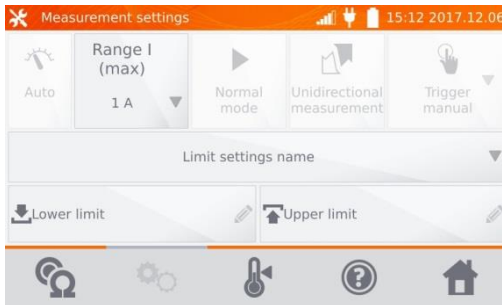

- 5 When necessary, select temperature limits from the database (click **Limit settings' name**) or set the required limits for the performed measurement by clicking **Lower limit** and/or **Upper limit**.

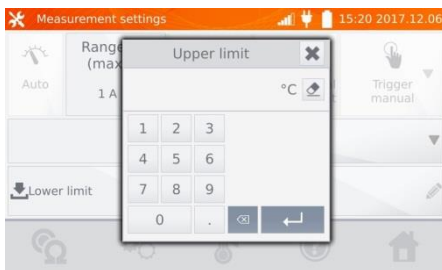
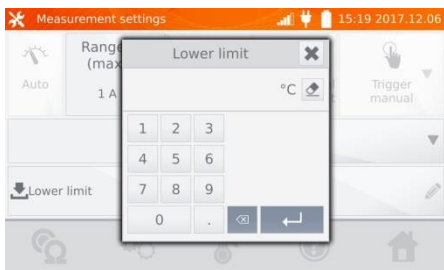
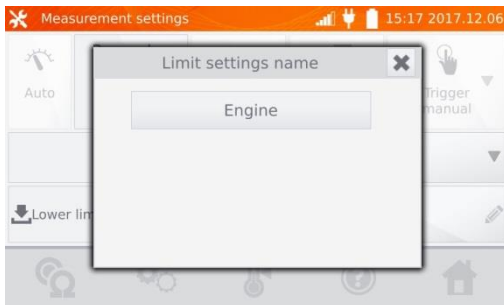

- 6 Click , to enter the temperature settings.

Enter the ambient temperature – optional.

Enter the temperature of the object or measure it with a thermometer connected to the meter socket.

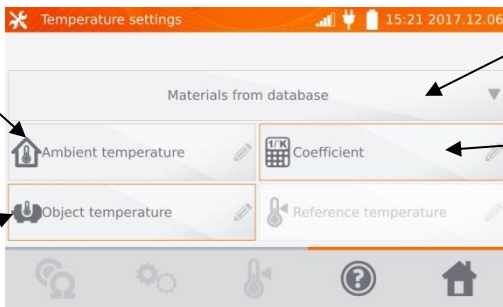

Select a material from the database or

Enter a coefficient for the tested object

**Note:**

- Entering factor  $\alpha$  and the temperature of the object is necessary to enter the measurement screen.

- 7 Press , to enter the measurement.



- 8 Connect the meter to the motor windings. Press **START/STOP**.

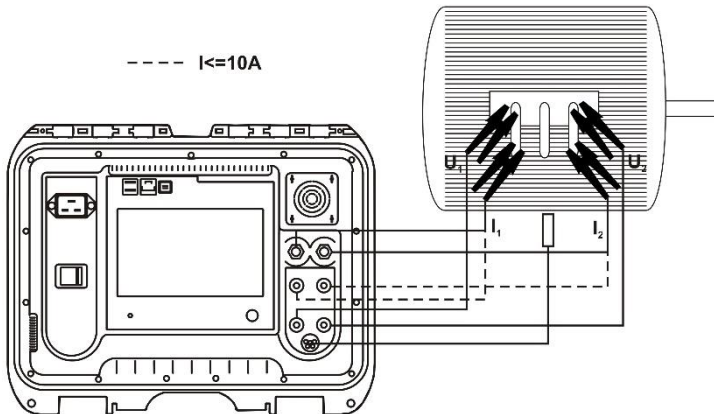

- 9 Disconnect the test leads from the motor, start the motor.

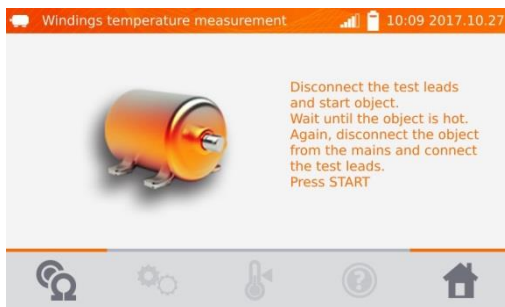

- 10 After the desired working time turn off the engine, reconnect the meter to the motor winding and press **START/STOP**.



$R_{T1}$  – resistance of the cold winding

$R_{T2}$  – resistance of the hot winding

$T_1$  – temperature of the cold object

$T_a$  – ambient temperature

$\alpha$  – temperature coefficient of resistance

↑ - upper limit

↓ - lower limit

## 4 Memory

### 4.1 Memory management (clients, objects, measuring points and logs)

#### Note:

- The memory may be organized before the measurements, or on a regular basis, after the measurement.

#### 4.1.1 Entering the clients

1

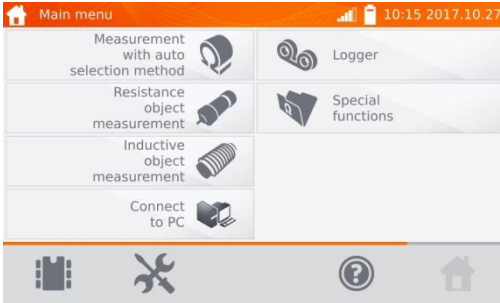



Click , to enter the memory.

#### Note:

- Use  button to enter the memory management for measurements results or to enter a higher level in the memory.

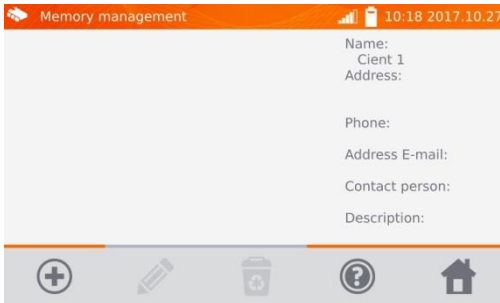
2



To add a client, click  button.

3

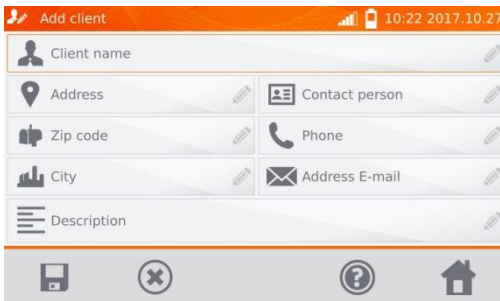

By clicking the individual fields, enter customer data using the keyboard. Client's name (box marked in orange) is mandatory.



4

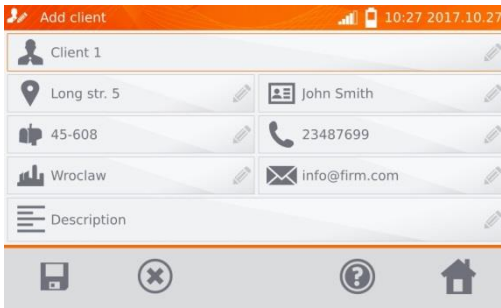

Use  button to save client's data in the memory.

5

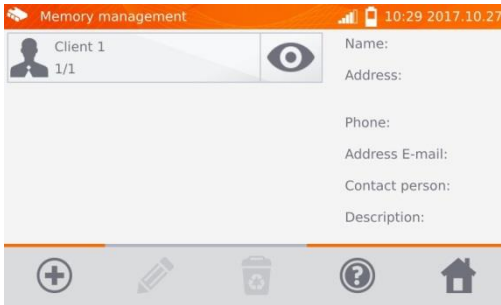

## 4.1.2 Entering objects, subobjects, measurement points and logs

### 4.1.2.1 Entering objects and subobjects

1

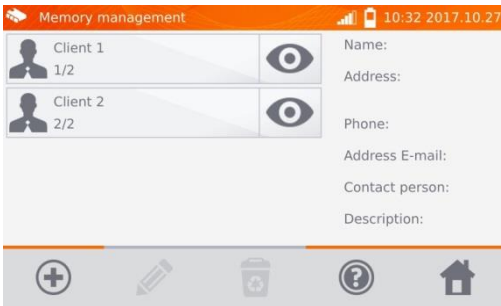

Click  of the selected client.

2

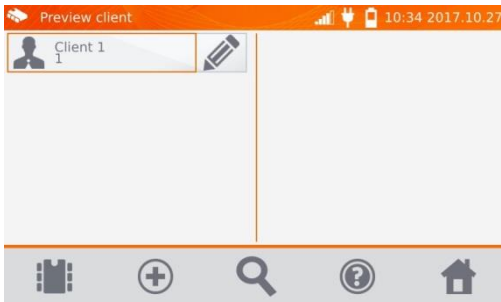

To add an object, measuring point or log, click  button.

3

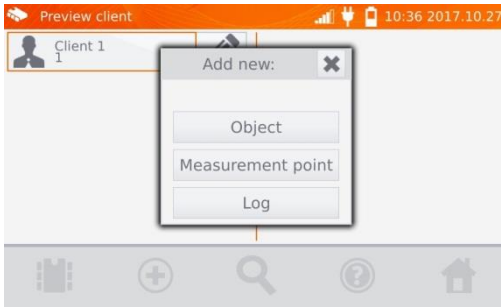

Click **Object** button.

4

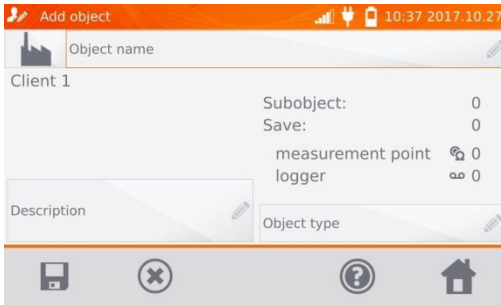

Click **Object name** box, to name the object - mandatory.

5



Select one of the default names or enter your own.

6

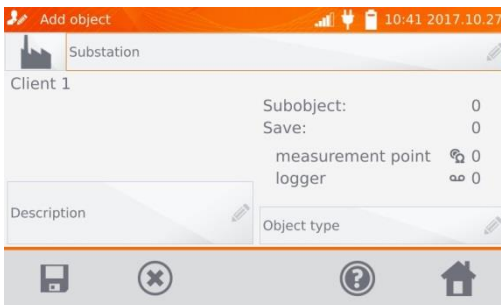

You may attach an additional description by clicking **Description** box. By clicking **Object type** box, you may select the default type of or enter your own.

7



Select one of the default names or enter your own.

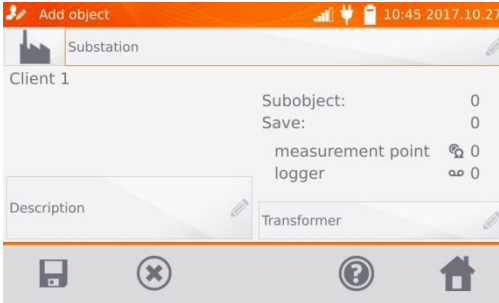

8

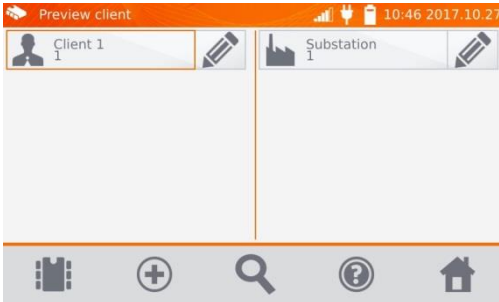

Use  button, to save the object in the memory.

9



By clicking  you can add more objects. By clicking the object field and , you may enter subobjects in the object etc.- up to 4 levels.

10

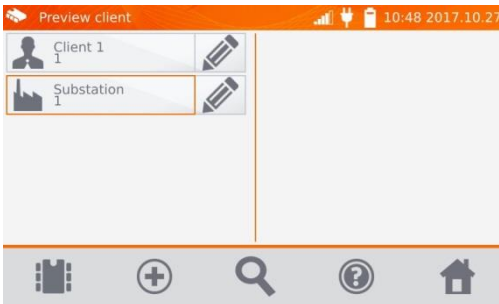

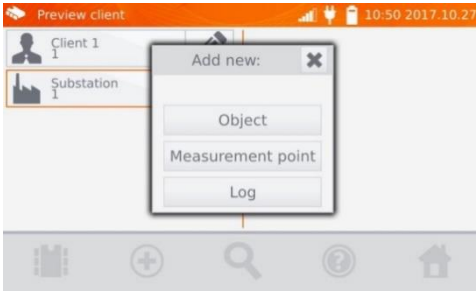



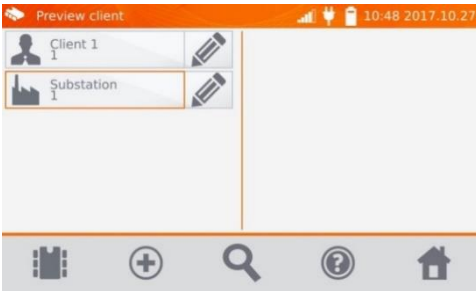

#### 4.1.2.2 Entering measurement points and logs

Measuring points and logs may be entered at any memory level, i.e. at the level of client object or subobject. Log is a measuring point distinguished due to performing a series of measurements in one point.

①



Click  of the client, and then  or press button at the level of the object (subobject). .

②

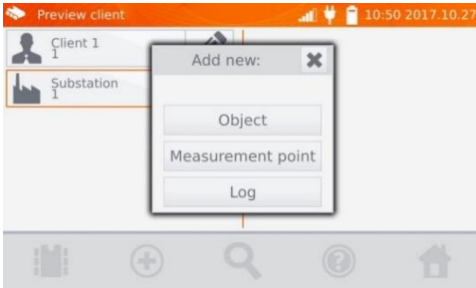

Click **Measurement point** button or **Log** button.

③

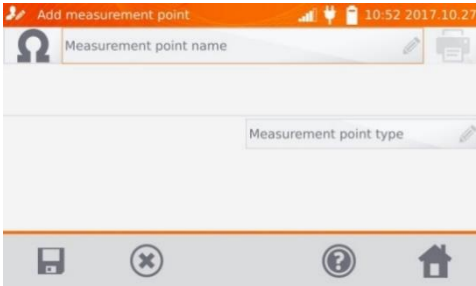

Click **Measurement point name** to name it - mandatory.

4



Select one of the default names or enter your own.

5

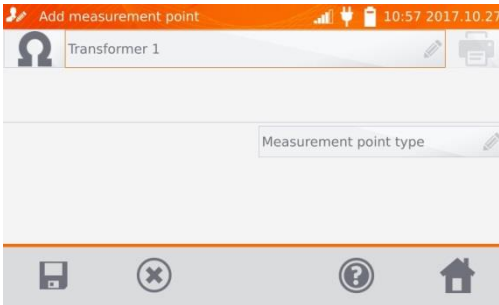

By clicking **Measurement point type** box, you may select the default type of or enter your own.

For logging, it is possible to add an additional description, similarly as for the object.

6

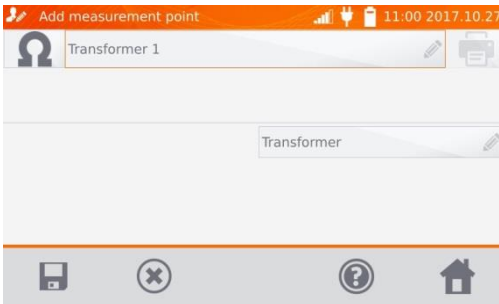

Use  button to enter a measuring point or log to the memory.

7

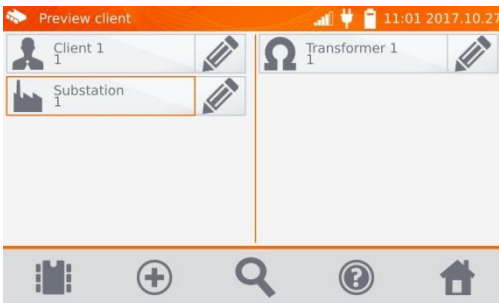

## 4.2 Storing the measurement results in the memory

### Notes:

- Before performing the next series of measurements at the same measuring points, the previous results must be archived, because for one measuring point, you can save only one result and entering the next will erase the previous one.
- The measurement result may be entered only to the measuring point or to logger.

### 4.2.1 Entering the results of measurements with previously organized memory

1



After finishing the measurement press .

2

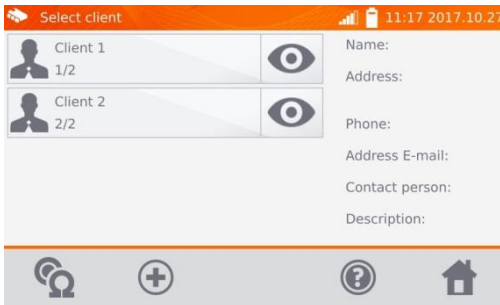

Select the client by clicking  button next to its name.

3

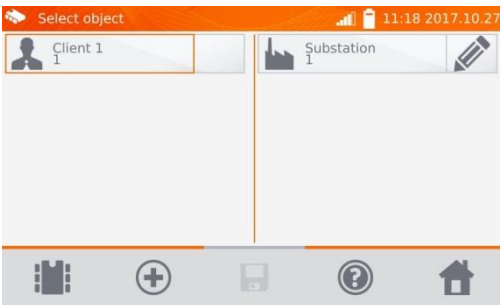

Select the object (subobject) by clicking its name.

4

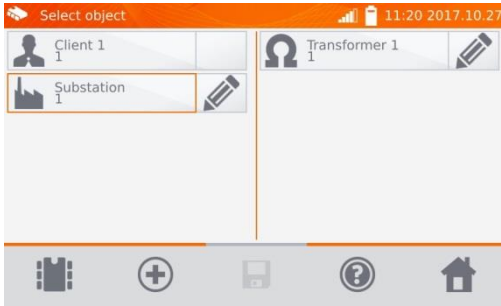

Select the measuring point by clicking its name (indicated by orange border).

5

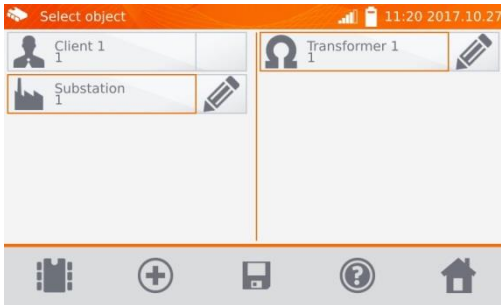

Save the result by clicking  button.

## 4.2.2 Entering the results of measurements without previously organized memory

### Method 1

1



After finishing the measurement press .

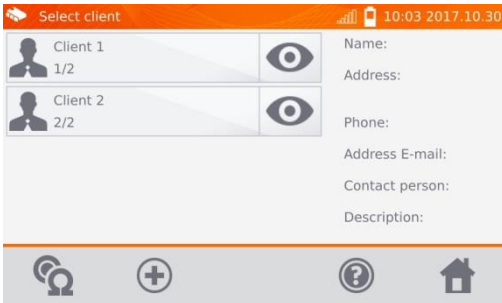

2

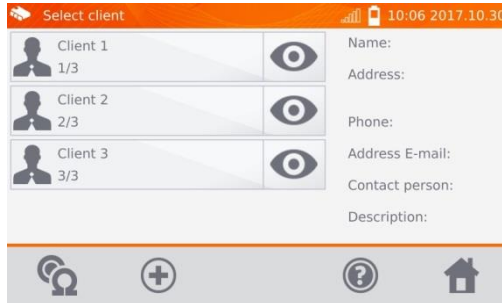

Click , to add a client.

3



After saving the client click its button  and then click button  to add the object

4

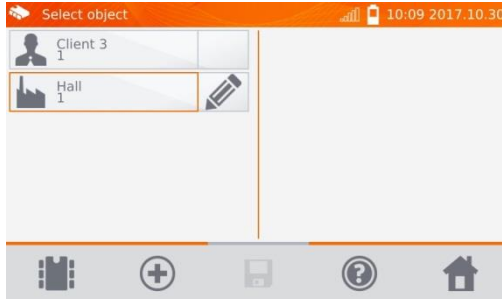

After adding and saving the object (also subobjects if necessary), click  button to add the measurement point.



5

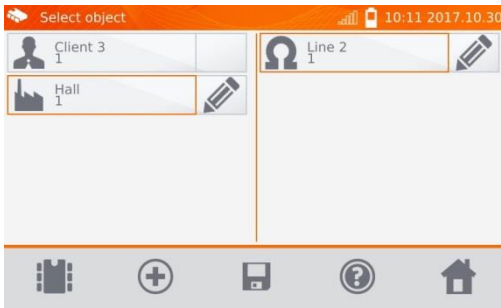

After adding and saving the measuring point, click . The result is saved to memory, the meter returns to the measuring mode.

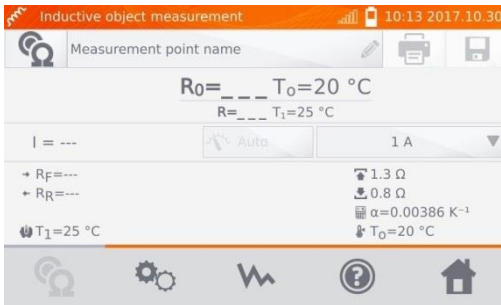

## Method 2

1



After the measurement or before it, click **Measurement point name** and enter the name.

2



After finishing the measurement press .

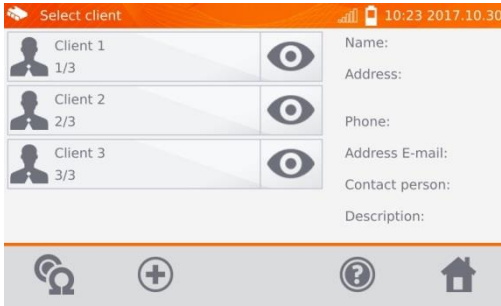

3



Click , to add a client.

4



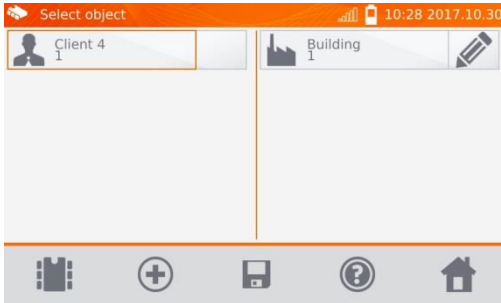

After saving the client click its button  and then click button  to add the object

5



After adding and saving the object (also subobjects if necessary), click the object and then , the measuring point with the measurement result will be saved automatically.

**Note:**

- Having selected the client and object (subobjects) and performing a series of measurements on one object, after the measurement and entering the name of the measuring point, click  and on the displayed screen click again , the measuring point with the measurement result will be saved automatically.

### 4.3 Viewing memory data

1

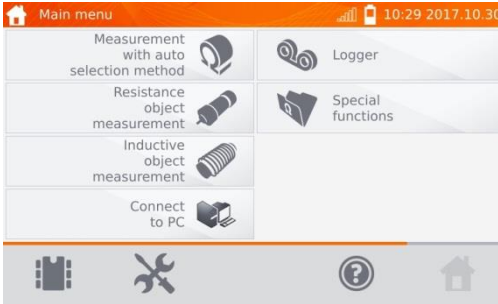

Click , to enter the memory.

2

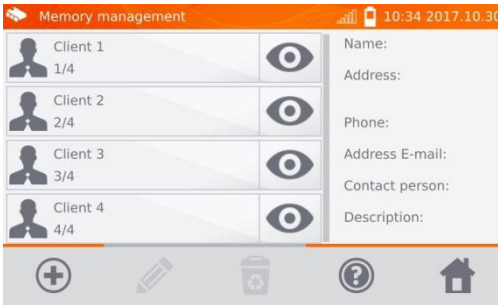





Click  of the selected object and then click on the object, subobjects, measuring point or logger.

3

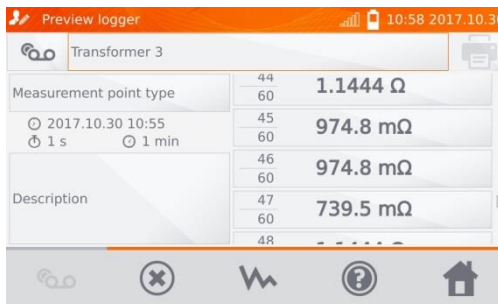

4



When using the logger, clicking the field with results will cause the meter to display the individual samples. You may scroll them using ,  buttons. Use  button to display the graph.

5

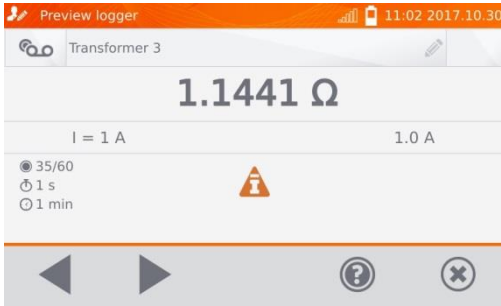

#### 4.4 "Search" in the memory

In order to facilitate searching for an object or device in the memory, a function of memory search is added. To start the function of searching in the memory:

1



Click .

2

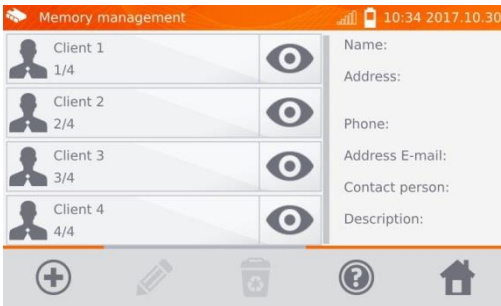

Click  of the selected client.

3

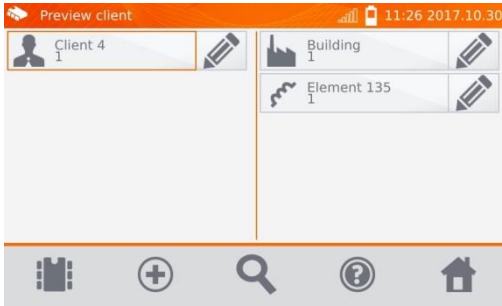

In any of the client's window, click  button.

4

Mark appropriate positions

Enter the object type or select the default type

Enter the relevant dates

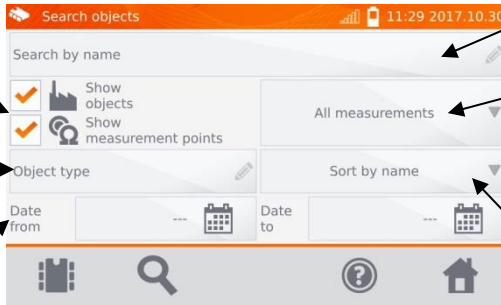



Enter the name or its several subsequent letters.

Select the type of the tested object:  
- all  
- resistive  
- inductive

Selecting sorting by name or date

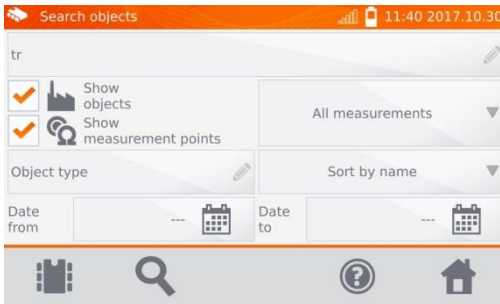
5



After entering all the search criteria, click  button again.

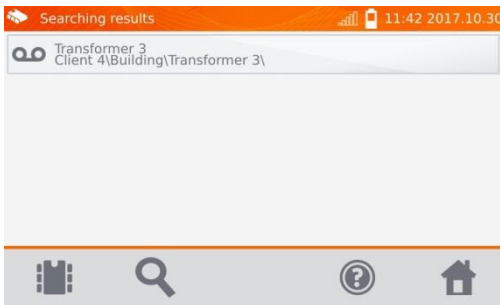



**Notes:**

- To perform the search, enter the name (or its part) or one of the dates.
- The size of letters in the name of searched item is ignored.

## 4.5 Copying customer data from the memory to USB stick and vice versa

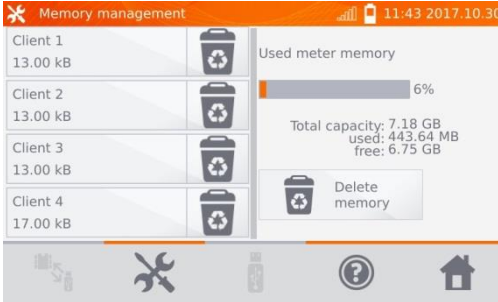
1





In the main menu, click button , then **Memory settings** and **Memory management**.

2

Insert the USB stick into the appropriate USB slot of the meter.

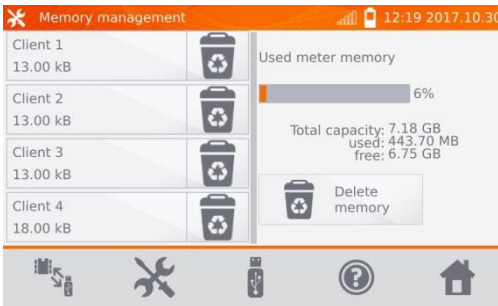
3



Click  to display the memory of the pendrive.

4

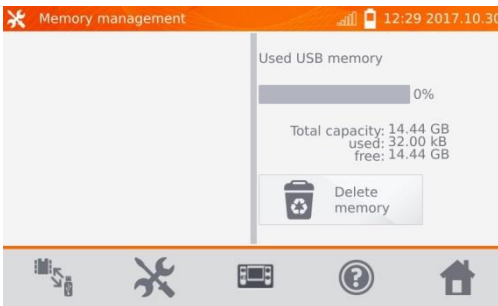



Click  to display the memory of the meter.

Click  to copy data.

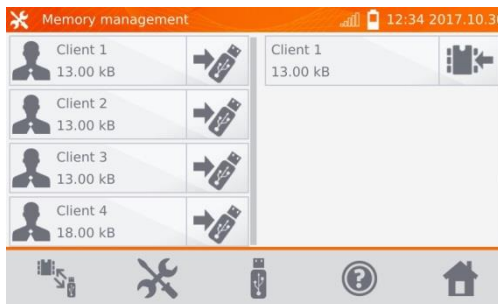
5



Click , to save data in the USB stick or  to copy data from the USB stick to the memory of the meter.

## 4.6 Deleting memory data

1

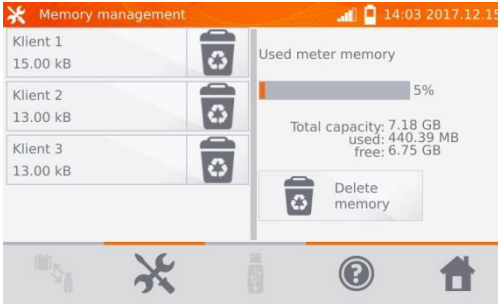

To delete the whole memory, click **Delete memory** button.

2

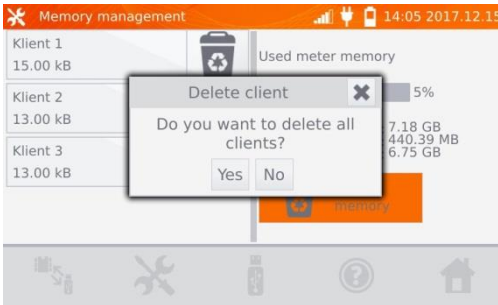

Click **YES**, to confirm deleting or **NO**, to cancel it.

1

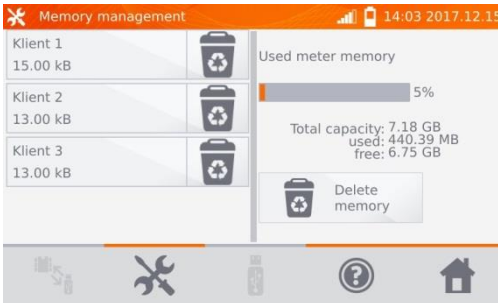

To delete a client, click  button next to its name.

2

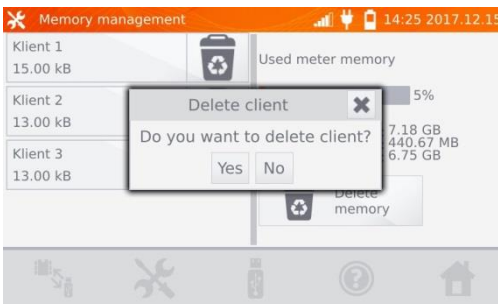

Click **YES**, to confirm deleting or **NO**, to cancel it.

1

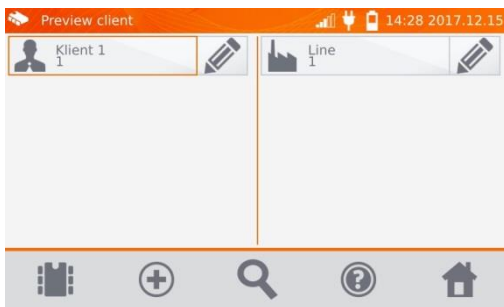

To delete an object or the measuring point / log, enter its edition by clicking ...  ...

2

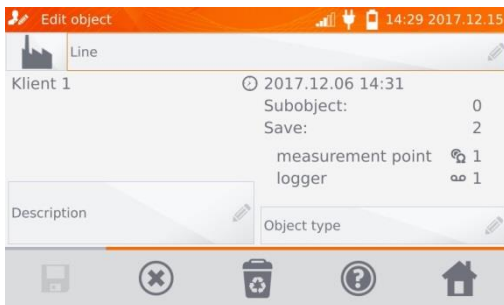

...and then click  button.

3

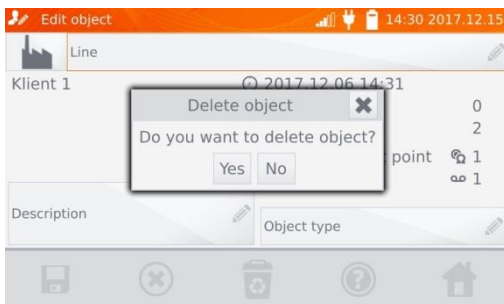

Click **YES**, to confirm deleting or **NO**, to cancel it.



## 5 Report printing

- Sato CG2 printer must be connected to any of the USB socket of "Host" type. You can print measurement results directly after the measurement or those stored in the memory . To print the result, click icon .

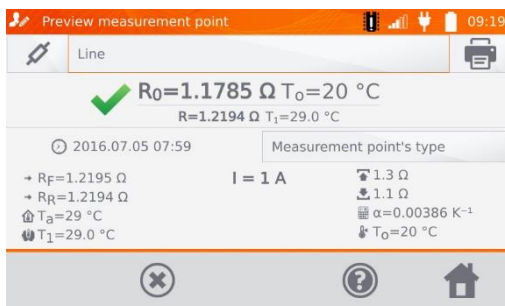

The printout includes all the results and parameters of the measurement, assessment (positive/negative), the date and time of measurement and data of person performing it, entered in the printer settings.

### Note:

- log results are not printed.

## 6 Barcode reader

If the tested object has a label with the results of previous measurement and a barcode reader, use a barcode reader connected to the meter and scan the code to set the object's measurement parameters. Scanning the barcode with the main menu displayed will give the meter the access to the encoded measurement.

To adapt a newly purchased DS4208 reader to work with the meter, connect it to the USB port of running computer and read the following code:



## 7 Power supply

The meters are powered by an AC adapter or a battery pack. When supplied from the mains, the battery pack is charged.

### 7.1 Monitoring the power supply voltage

The charge level of the battery pack is indicated by the symbol in the right upper corner of the display on a current basis:



- the battery pack is charged.



- the battery pack is discharged.



- the battery pack is being charged.

#### Note:

- Remember that measurements performed with an insufficient supply voltage feature additional errors which the user is unable to evaluate. Consequently, such measurements cannot prove that the results of resistance measurements are correct.
- Electric socket used to power the MMR meter should be grounded.

### 7.2 General rules for using Li-Ion rechargeable batteries

- Store the meter with half-charged battery pack in a dry, cool and well ventilated place and protect it from direct sunlight. The battery pack may be damaged if stored when fully discharged. The ambient temperature for prolonged storage should be maintained within the range of 5°C...25°C.

- Charge the batteries in a cool, well-ventilated place at a temperature of 10°C ... 28°C. Build-in charger detects both too low and too high temperature of rechargeable battery and blocks the charging process. Charging in too low temperature might irreparably damage rechargeable batteries. The increase in temperature of the battery pack may cause electrolyte leakage and even its ignition or explosion.

- Do not charge or use the batteries in extreme temperatures. Extreme temperatures reduce the lifetime of rechargeable batteries. Always observe the rated operating temperature. Do not dispose the battery pack into fire.

- Li-Ion cells are sensitive to mechanical damage. This kind of damage may cause its permanent damage and thus - ignition or explosion. Any interference in the structure of Li-ion battery pack may cause its damage. This may result in the ignition or explosion. A short-circuit of the battery poles "+" and "-" may permanently damage the battery pack or even cause its fire or explosion.

- Do not immerse Li-Ion battery in liquids and do not store in humid conditions.

- If the electrolyte contained in the Lithium-Ion battery pack, contacts eyes or skin, immediately rinse the affected place with plenty of water and consult a doctor. Protect the battery against unauthorised persons and children.

- When you notice any changes in the Lithium-Ion battery pack (e.g. changes in colour, swelling, excessive temperature), stop using the battery pack. Li-Ion batteries that are mechanically damaged, overcharged or excessively discharged are not suitable for use.

- any misuse of the battery may cause its permanent damage. This may result in the ignition. The seller and the manufacturer shall not be liable for any damages resulting from improper handling Li-Ion battery pack.

### **7.3 Battery pack charging procedure**

Charging the battery pack is possible only when the meter is on. This is caused by application of high power power supplies, which need active cooling (fans) while working. The fan noise is present while charging.

In order to charge the meter, connect it to the power grid and then turn the device on. After starting the meter enables the charging procedure. The charge level of the battery pack is indicated with the icon described in chapter 7.1.

## **8 Cleaning and maintenance**

**CAUTION!**  
**Apply only maintenance methods specified by the manufacturer in this manual.**

The casing of the meter may be cleaned with a soft, damp cloth using all-purpose detergents. Do not use any solvents or cleaning agents which may scratch the casing (powders, pastes, etc.).

The electronic system of the meter does not require maintenance.

## **9 Storage**

In the case of storage of the device, the following recommendations must be observed:

- Disconnect all the test leads from the meter.
- make sure that the meter and accessories are dry,
- during prolonged storage remove the batteries
- storage temperatures must be in accordance with those defined in technical specifications,
- in order to prevent total discharge of the rechargeable batteries during prolonged storage, charge them from time to time.

## **10 Dismantling and disposal**

Worn-out electric and electronic equipment should be gathered selectively, i.e. it must not be placed with waste of another kind.

Worn-out electronic equipment should be sent to a collection point in accordance with the law of waste electrical and electronic equipment.

Before the equipment is sent to a collection point, do not dismantle any elements.

Observe the local regulations concerning disposal of packages, worn-out batteries and accumulators.

# 11 Technical data

## 11.1 Basic data

⇒ Abbreviation "m.v." used in the specification of accuracy means a standard measured value.

Uncertainty values stated in the table refer to the measurement with bidirectional current and relate to the average of two measurements according to the following formula:

$$R = \frac{R_F + R_R}{2}, \text{ where } R_F - \text{resistance at the assumed "forward" current direction and } R_R - \text{resistance}$$

at the assumed "backward" current direction. For measuring with unidirectional current, the specified accuracy is not guaranteed.

### Measurement of resistance



Range	Resolution	Accuracy *	Measuring current
0.0 μΩ...999.9 μΩ	0.1 μΩ	±(0.25% + 2 digits)	MMR-6700   100 A < I ≤ 200 A
0.0 μΩ...999.9 μΩ	0.1 μΩ		50 A < I ≤ 100 A
1.0000 mΩ...1.9999 mΩ	0.0001 mΩ		20 A < I ≤ 50 A
0.0 μΩ...999.9 μΩ	0.1 μΩ		10 A < I ≤ 20 A
1.0000 mΩ...3.9999 mΩ	0.0001 mΩ		
0.0 μΩ...999.9 μΩ	0.1 μΩ		
1.0000 mΩ...7.9999 mΩ	0.0001 mΩ		

Range	Resolution	Accuracy *	Measuring current / voltage **
0 μΩ...999.9 μΩ	0.1 μΩ	±(0.25% m.v. + 2 digits)	10 A (20 mV)
1.0000 mΩ...1.9999 mΩ	0.0001 mΩ		10 A (200 mV)
2.000 mΩ...19.999 mΩ	0.001 mΩ		10 A / 1 A (2 V / 200 mV)
20.00 mΩ...199.99 mΩ	0.01 mΩ		1 A / 0.1 A (2 V / 200 mV)
200.0 mΩ...999.9 mΩ	0.1 mΩ		0,1 A (2 V)
1.0000 Ω...1.9999 Ω	0.0001 Ω		10 mA (2 V)
2.000 Ω...19.999 Ω	0.001 Ω		1 mA (2 V)
20.00 Ω...199.99 Ω	0.01 Ω		
200.0 Ω...1999.9 Ω	0.1 Ω		

\* - for measurements on inductive objects in fast mode: ±(2% m.v. + 2 digits)

\*\* - applies to measurements on resistance objects, for measurements on inductive objects output voltage ≤ 5 V

### Resistance measurement in the presence of noise of 50 Hz or 60 Hz

Signal/noise ratio	Additional uncertainty	Signalling
$N \geq 0.02$	-	-
$0.02 > N \geq 0.004$	1%	
$N < 0.004$	unspecified	

### Measuring current settings

Resistance measurements of resistive objects:

- **MMR-6500** | 1 mA, 10 mA, 100 mA, 1 A, 10 A, 50 A, 100 A or within range of 10 A...100 A in steps of 10 A
- **MMR-6700** | 1 mA, 10 mA, 100 mA, 1 A, 10 A, 50 A, 100 A, 200 A or within range of 10 A...200 A in steps of 10 A

Resistance measurements of inductive objects:

- 1 mA, 10 mA, 100 mA, 1 A, 10 A

## 11.2 Other technical data

- a) insulation type acc. to EN 61010-1 ..... double
- b) overvoltage category acc. to EN 61010-2-030
  - measuring side ..... CAT IV 50 V
  - mains power supply ..... CAT II 300 V
- c) ingress protection acc. to EN 60529
  - with closed housing ..... IP67
  - with open housing, powered from mains or batteries ..... IP40
- d) power supply ..... Li-Ion rechargeable battery 7.2 V 8.8 Ah
- e) mains supply
  - MMR-6500 ..... 100 V..265 V/50 Hz..60 Hz, I<sub>max</sub> 10 A, P<sub>max</sub> 700 W
  - MMR-6700 ..... 100 V..265 V/50 Hz..60 Hz, I<sub>max</sub> 16 A, P<sub>max</sub> 1200 W
- f) battery charging time ..... approx. 3.5 h
- g) number of measurements with 10A current performed when powered from the battery pack ..... 200..250, depending on the ambient temperature
- h) maximum wire resistance for 10 A current ..... 250 mΩ
- i) accuracy of measuring current setting ..... ±10%
- j) time of performing the resistance measurement
  - with selected resistive object type and bidirectional current flow ..... 7..15 s
  - ..... depending on the measuring current
  - with selected inductive object type, dependent on the resistance and inductance of the object ..... 10 s or more
- k) dimensions ..... 390 mm x 308 mm x 172 mm
- l) meter weight
  - MMR-6500 ..... approx. 8.2 kg
  - MMR-6700 ..... approx. 8.7 kg
- m) operating temperature ..... -10°C...+50°C
- n) charger operating temperature ..... 0°C...+45°C
- o) storage temperature ..... -20°C...+60°C
- p) humidity ..... 20%...90%
- q) reference temperature ..... +23°C ± 2°C
- r) reference humidity ..... 40%..60%
- s) altitude (above sea level): ..... <2000 m
- t) temperature coefficient ..... ±0.01% of d.v./ °C ±0.1 digit / °C
- u) TFT graphic display ..... 800x480 points
- v) interface standard ..... USB, LAN
- w) quality standard, design and manufacturing ..... ISO 9001 compliant
- x) the product meets the EMC requirements according to ..... EN 61326-1 and EN 61326-2-2

**Note:**

- **During the measurement, when the meter is connected to the measured object and the output current exceeds 10 A, a temporary increase of radiated emission level may occur (EN 61326-1 point 4).**
- **The LAN port may be used to communicate with an external system. This function is optional, available on special order.**

**Note:**

SONEL S.A. hereby declares that the radio device type MMR-6500/6700 complies with Directive 2014/53/EU. The full text of the EU Declaration of Conformity is available at the following website address: <https://sonel.pl/en/download/declaration-of-conformity/>

## 12 Manufacturer

The manufacturer of the device and provider of guarantee and post-guarantee service:

**SONEL S.A.**  
Wokulskiego 11  
58-100 Świdnica  
Poland  
tel. +48 74 884 10 53 (Customer Service)  
e-mail: [customerservice@sonel.com](mailto:customerservice@sonel.com)  
web page: [www.sonel.com](http://www.sonel.com)

**Note:**  
**Service repairs must be performed only by the manufacturer.**

## SYMBOLS DISPLAYED BY THE METER

	Memory		Saving to memory
	Settings		Report print
	Return to the main menu		Temperature measurement, reference temperature
	Help		Presentation of measurement results in the form of a time chart
	Adding a client, object or measurement point		Exit from the option
	Searching for an object or measurement point		Wi-Fi signal strength
	Entry to client objects		There was a limitation of the measuring current to a value lower than that ensuring maximum accuracy
	Entry to client, object or measurement point edition, with a possibility of changing data		Test leads interchanged
	Fast entry deletion on the on- screen keyboard		High level of noise (interference), measurement possible with additional uncertainty
	Deletion of a measurement point, object or client		High level of noise (interference), measurement possible without defining uncertainty
	Measuring mode		Measuring current greater than 10 A blocked
	Recording mode		No clamps connected
	Measurement setup mode		Exceeded temperature of terminal I1 or I2



**SONEL S.A.**

Wokulskiego 11  
58-100 Świdnica  
Poland

**Customer Service**

tel. +48 74 884 10 53  
e-mail: [customerservice@sonel.com](mailto:customerservice@sonel.com)

[www.sonel.com](http://www.sonel.com)